

# Bailey



**Catalogue Lampes**

**Lampes miniatures**

*for all your lamps*



# Bailey

BE&E



*for all your lamps*

**Caelli** LUCE

**RIVA**

**MEGAMAN**  
spaarlampen



**PHILIPS**

**NARVA**

**OSRAM**



**SYLVANIA**

**LEG**  
ILLUMINATION

**KANDOLite**

Bailey est spécialisée dans le domaine de l'éclairage. Nous vendons des lampes miniatures, mais également des lampes halogènes, des lampes Leds, des lampes à économie d'énergie, des lampes automobiles et pour le transport, des lampes spéciales et des lampes domestiques à de multiples clients dans le monde entier. N'hésitez pas à visiter notre site pour en savoir plus sur notre société et nos produits : [www.bailey.nl](http://www.bailey.nl)

## TABLE DES MATIERES

### PART M

#### Lampes miniatures

<b>Micro-lampes à fils souples</b> .....	M1
T3/4 .....	M1
T1 .....	M2
T1 1/4 .....	M3
T1 1/2 .....	M4
T1 3/4 .....	M5
Axiales.....	M6
 <b>Micro-lampes à fils isolés</b> .....	M7
T1 1/4 .....	M7
 <b>Bi-Pin</b> .....	M8
T1 .....	M8
T1 Spéciale .....	M11
T1 1/4 .....	M12
T1 3/4 .....	M13
Terasaki .....	M14
 <b>Midget Flanged</b> .....	M15
T3/4 .....	M15
T1 Norme US .....	M16
T1 Norme française.....	M17
T1 1/4 .....	M18
T1 3/4 .....	M19
 <b>Midget Grooved</b> .....	M21
T1 3/4 .....	M21
 <b>Midget Trap</b> .....	M23
T1 3/4 .....	M23
 <b>Midget Screw E5/8</b> .....	M24
T1 3/4 .....	M24
 <b>Midget Bayonet</b> .....	M26
T1 3/4 .....	M26
 <b>Culot Verre / Wedge</b> .....	M27
T5.....	M27
T5 Culot plastique .....	M28
T10 .....	M29
T10 Xénon.....	M30
T15 .....	M31
Neo-Wedge support plastique.....	M32

## TABLE DES MATIERES

<b>Lampes Téléphoniques</b> .....	M33
T4.5.....	M33
T4.6.....	M34
T5.5K .....	M35
T5.5.....	M37
T5.5 EUBA Type BELL.....	M39
T6.5F Culot français .....	M40
T6.8G Culot allemand.....	M42
T6.0 Culot suédois.....	M44
ESB.....	M45
PSB.....	M46
BPO Culot anglais .....	M47
F9.....	M48
T9.....	M49
<b>Lampes Ba7s</b> .....	M50
Tube.....	M50
<b>Lampes Ba9s</b> .....	M56
Tube.....	M56
Tube Telewriter.....	M67
Sphérique .....	M68
<b>Lampes Ba10s</b> .....	M72
Tube.....	M72
<b>Lampes E10</b> .....	M73
Tube.....	M73
Lampe tube pour télécriteur .....	M84
Lampe tube Sperry .....	M85
Sphérique .....	M86
Krypton .....	M91
Xénon .....	M92
Lampes pour Torches.....	M93
<b>P13.5s Préfocus</b> .....	M95
Lampes pour Torches.....	M95
<b>Lampes Ba15d</b> .....	M98
Tube.....	M98
Poirette .....	M105
<b>Lampes E12</b> .....	M106
Tube.....	M106
S6 Type US .....	M109
<b>Lampes E14</b> .....	M110
Tube.....	M110
Poirette .....	M119

## TABLE DES MATIERES

<b>Lampes Navettes</b> .....	M120
S6 .....	M120
S7 .....	M125
S8.5 .....	M129
S8.5 Xénon .....	M135
SF6 .....	M136
<b>Lampe navette à boucle</b> .....	M137
Xénon .....	M137
<b>Lampes Néon</b> .....	M138
Midget Flanged .....	M138
Midget Grooved .....	M139
Ba7s .....	M140
Lampes Téléphoniques .....	M141
Ba9s .....	M142
E10 .....	M143
Ba15d - Ba15s .....	M144
E12 .....	M145
E14 .....	M146
B22d - E27 .....	M147
<b>Accessoires</b> .....	M148
Tire-lampes .....	M148
Capuchons silicone .....	M149
<b>Filaments</b> .....	M150

# Bailey



## Lampes de couleur

Caelli LUCE

RIVA

MEGAMAN<sup>®</sup>  
spaarlampen



PHILIPS

NARVA

OSRAM

SYLVANIA



KANDOLite<sup>®</sup>



Nous pouvons fournir toutes les lampes miniatures dans les couleurs suivantes : bleu, vert, orange, rouge et jaune.

[www.bailey.nl](http://www.bailey.nl)

*for all your lamps*

# Bailey

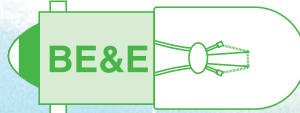

## Emballage spécial

**fael** LUCE®

**RIVA**

**MEGAMAN®**  
spaarlampen



**PHILIPS**

**NARVA**

**OSRAM** OSRAM

**SYLVANIA**



**KANDOLite®**



Nous pouvons fournir des emballages par 10 pièces en blanc neutre ou en couleur, étiquetés avec code à barres, logo et numéro d'article.

[www.bailey.nl](http://www.bailey.nl)

*for all your lamps*



## Micro-lampes à fils souples

**T3/4**

**2.5X5.0mm**

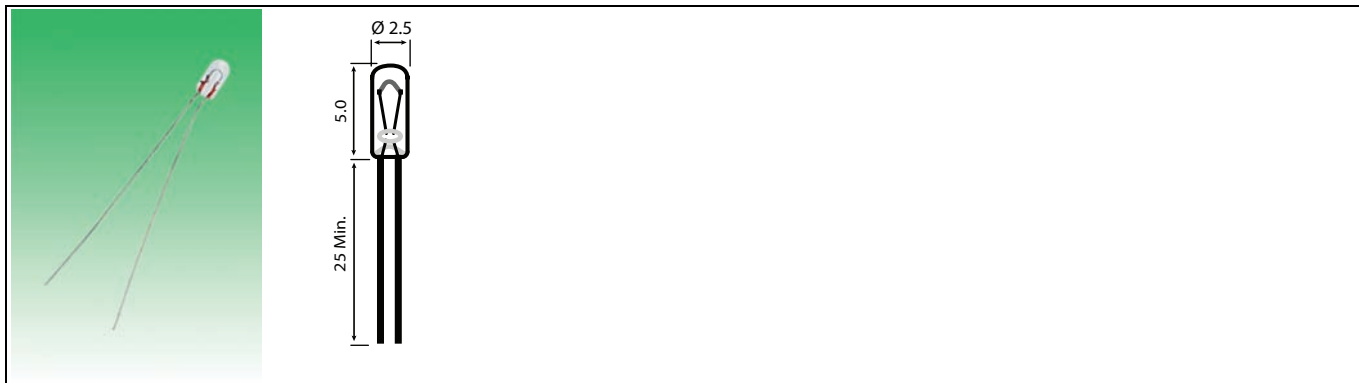

Numéro d'article	Voltage	Courant (A)	Filament	Teinte	Durée de vie (h)	mscp	Code US
WE02050601	5	0.060	C-2R	Clair	100000	0.050	6833
WE02050801	5	0.080	C-2R	Clair	15000	0.150	8666
WE02051151	5	0.115	C-2R	Clair	40000	0.150	7153
WE02120501	12	0.050	C-2V	Clair	15000	0.070	
WE02240201	24	0.020	C-2F	Clair	5000	0.035	

# Micro-lampes à fils souples

## T1

3.2X6.35mm

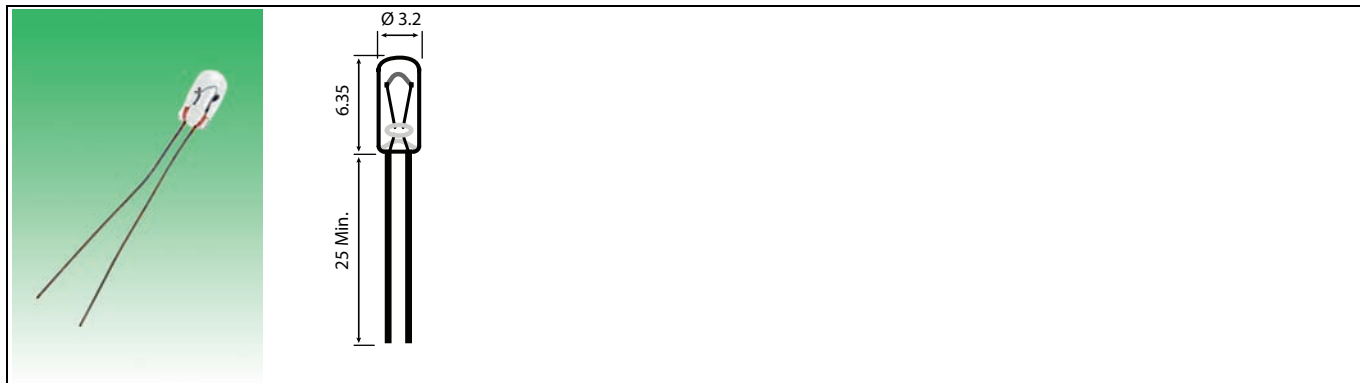

Numéro d'article	Voltage	Courant (A)	Filament	Teinte	Durée de vie (h)	mscp	Code US
WE03030151	3	0.015	C-2R	Clair	5000	0.020	7205
WE03050211	5	0.021	C-2R	Clair	10000	0.030	6022
WE03050301	5	0.030	C-2R	Clair	25000	0.030	7210
WE03050601	5	0.060	C-2R	Clair	60000	0.030	680
WE03050602	5	0.060	C-2R	Clair	40000	0.050	683
WE0305060L	5	0.060	C-2R	Lentille	25000		
WE03050751	5	0.075	C-2R	Clair	25000	0.090	713
WE03051151	5	0.115	C-2R	Clair	40000	0.150	715
WE03051251	5	0.125	C-2R	Clair	5000	0.220	7216
WE03060501	6	0.050	C-2V	Clair	15000		
WE03060601	6	0.060	C-2R	Clair	10000	0.120	
WE03060701	6	0.070	C-2R	Clair	10000	0.120	
WE03100271	10	0.027	C-2F	Clair	10000	0.100	7218
WE03120301	12	0.030	C-2F	Clair	5000	0.100	
WE03120401	12	0.040	C-2F	Clair	10000		7051
WE03120501	12	0.050	C-2F	Clair	10000	0.150	
WE03120601	12	0.060	C-2F	Clair	16000	0.150	7219
WE03130251	13	0.025	C-2F	Clair	5000		
WE03140401	14	0.040	C-2F	Clair	10000	0.090	871
WE03140651	14	0.065	C-2F	Clair	16000	0.150	8111
WE03140801	14	0.080	C-2F	Clair	10000		
WE03180261	18	0.026	C-2F	Clair	16000	0.150	7220
WE03240201	24	0.020	CC-2F	Clair	5000	0.050	
WE03280241	28	0.024	CC-2F	Clair	16000	0.150	6838
WE03280281	28	0.028	CC-2F	Clair	10000		
WE03360201	36	0.020	CC-2F	Clair	5000		

# Micro-lampes à fils souples

## T1 1/4

4.5X11.7mm

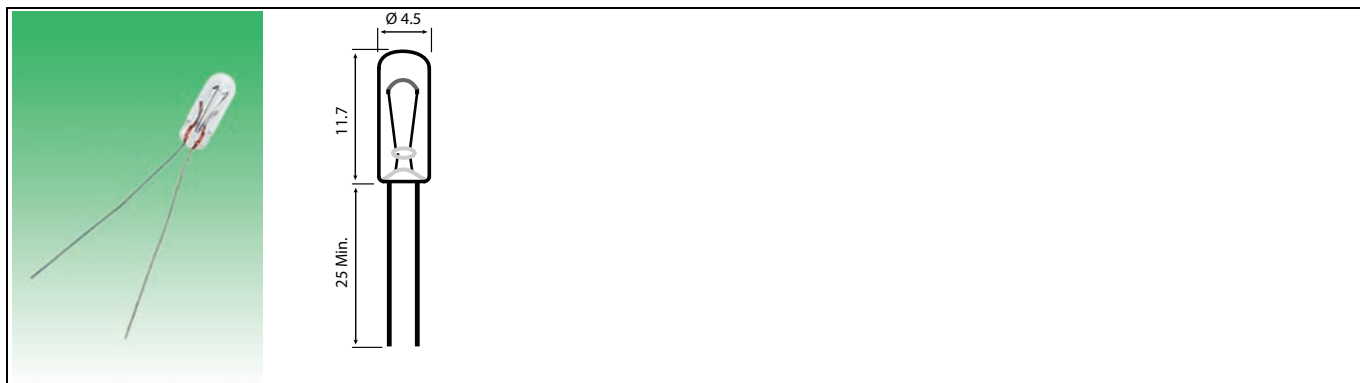

Numéro d'article	Voltage	Courant (A)	Filament	Teinte	Durée de vie (h)	mscp	Code US
WE04010301	1.3	0.030	C-2R	Clair	100	0.006	2135
WE04010701	1.5	0.070	C-2R	Clair	25000	0.016	749
WE04011001	1.5	0.100	C-2R	Clair	1000		
WE04031901	3	0.190	C-2R	Clair	350	0.250	324
WE04050601	5	0.060	C-2R	Clair	25000	0.050	583
WE04051151	5	0.115	C-2R	Clair	40000	0.150	515
WE04060301	6	0.030	C-2R	Clair	3000		
WE04060401	6	0.040	C-2V	Clair	10000	0.030	8661
WE04060601	6	0.060	C-2R	Clair	3000	0.130	2114
WE04061001	6	0.100	C-2R	Clair	6000		
WE04062001	6	0.200	C-2R	Clair	1000	0.630	634
WE04100151	10	0.015	C-2F	Clair	10000	0.003	8608
WE04120201	12	0.020	C-2F	Clair	5000		
WE04120351	12	0.035	C-2F	Clair	25000	0.050	772
WE04120401	12	0.040	C-2V	Clair	10000	0.090	
WE04120601	12	0.060	C-2F	Clair	15000	0.150	753
WE04120801	12	0.080	C-2V	Clair	1000	0.400	754
WE04121001	12	0.100	C-2V	Clair	1000	0.250	
WE04130301	13.5	0.030	C-2F	Clair	15000		
WE04140801	14	0.080	C-2F	Clair	1000	0.500	8640
WE04160301	16	0.030	C-2F	Clair	1000		
WE04240351	24	0.035	C-2F	Clair	25000	0.100	
WE04240352	24	0.035	C-2F	Clair	5000	0.150	770
WE04240401	24	0.040	C-2F	Clair	5000		
WE04280251	28	0.025	C-2F	Clair	5000	0.080	
WE04280401	28	0.040	C-2F	Clair	1000	0.340	8627
WE04480251	48	0.025	CC-2F	Clair	1000	0.200	

# Micro-lampes à fils souples

**T1 1/2**

**4.9X13mm**

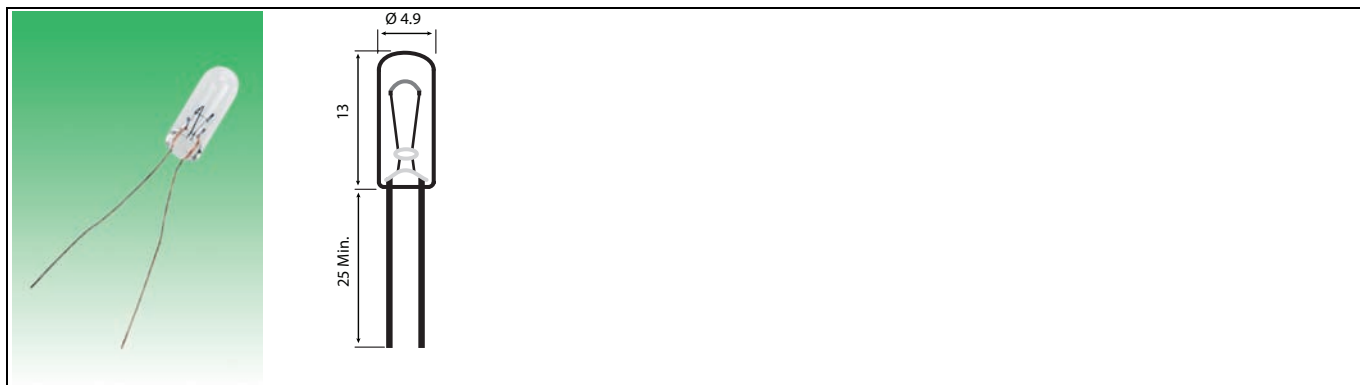

Numéro d'article	Voltage	Courant (A)	Filament	Teinte	Durée de vie (h)	mscp	Code US
WE05010601	1.35	0.060	C-2R	Clair	100	0.030	
WE05040601	4.5	0.060	C-2R	Clair	2000	0.100	
WE05060401	6	0.040	C-2V	Clair	10000	0.040	
WE05062001	6	0.200	C-2R	Clair	2000	0.630	192
WE05060402	6.3	0.040	C-2V	Clair	10000		
WE05062002	6.3	0.200	C-2F	Clair	5000	0.400	
WE05120301	12	0.030	C-2V	Clair	1000	0.100	
WE05120401	12	0.040	C-2F	Clair	4000	0.090	
WE05120402	12	0.040	C-2F	Clair	10000		
WE05120501	12	0.050	C-2V	Clair	1000	0.240	
WE05120801	12	0.080	C-2V	Clair	5000	0.160	
WE05121001	12	0.100	C-2V	Clair	5000	0.270	
WE05240351	24	0.035	C-2F	Clair	8000	0.150	
WE05280401	28	0.040	C-2F	Clair	7000	0.300	
WE05280402	28	0.040	C-2F	Clair	4000	0.340	194

# Micro-lampes à fils souples

## T1 3/4

5.7X13.2mm

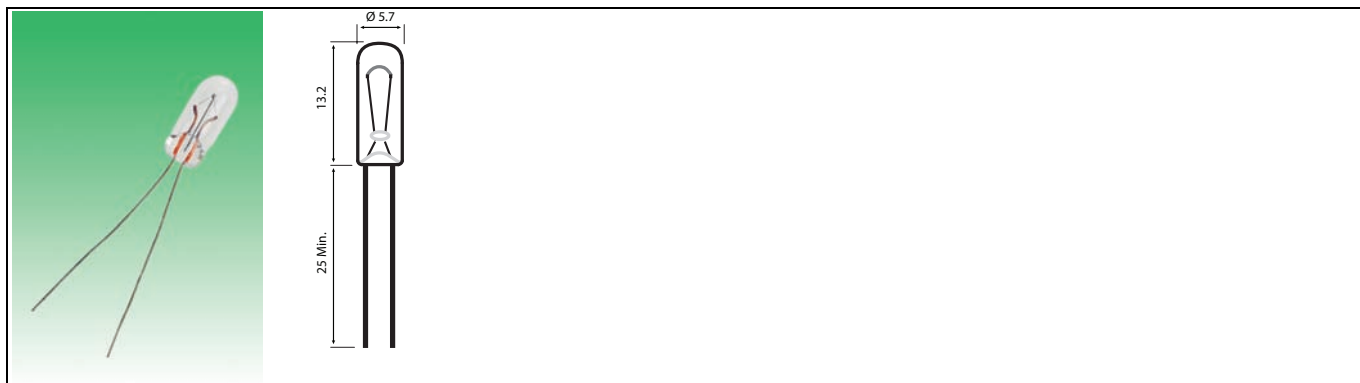

Numéro d'article	Voltage	Courant (A)	Filament	Teinte	Durée de vie (h)	mscp	Code US
WE06023501	2.5	0.350	C-2R	Clair	10000	0.210	2169
WE06030151	3	0.015	C-2R	Clair	10000	0.003	2158
WE06050151	5	0.015	C-2V	Clair	10000	0.015	
WE06050601	5	0.060	C-2R	Clair	25000	0.050	2200
WE06060401	6	0.040	C-2V	Clair	10000	0.030	1730
WE06061001	6	0.100	C-2V	Clair	10000	0.120	
WE06062001	6	0.200	C-2R	Clair	1000	0.340	1784
WE06060402	6.3	0.040	C-2V	Clair	10000	0.030	2180
WE06060752	6.3	0.075	C-2R	Clair	500	0.230	1739
WE06062002	6.3	0.200	C-2F	Clair	20000	0.400	2181
WE06062003	6.3	0.200	C-2R	Clair	5000	0.550	2112
WE06100151	10	0.015	C-2F	Clair	10000	0.003	1869
WE06120401	12	0.040	C-2F	Clair	10000	0.120	2174
WE06120601	12	0.060	C-2F	Clair	10000	0.160	
WE06140801	14	0.080	C-2F	Clair	40000	0.300	2182
WE06140802	14	0.080	C-2F	Clair	2500	0.500	1705
WE06141001	14	0.100	C-2F	Clair	10000	0.500	2162
WE06180401	18	0.040	C-2F	Clair	10000	0.150	2102
WE06240401	24	0.040	C-2F	Clair	5000	0.150	
WE06240501	24	0.050	C-2F	Clair	1000	0.500	2176
WE06240601	24	0.060	C-2F	Clair	5000	0.500	2041
WE06280241	28	0.024	C-2F	Clair	4000	0.150	6033
WE06280401	28	0.040	C-2F	Clair	10000	0.150	2185
WE06280402	28	0.040	C-2F	Clair	7000	0.300	2187
WE06280403	28	0.040	C-2F	Clair	4000	0.340	1764
WE06280601	28	0.060	C-2F	Clair	25000	0.340	1764LSV
WE06360201	36	0.020	C-2F	Clair	5000	0.200	
WE06480201	48	0.020	CC-2F	Clair	5000	0.200	
WE06600201	60	0.020	CC-2F	Clair	5000	0.150	

# Micro-lampes à fils souples

## Axiales

4X19mm

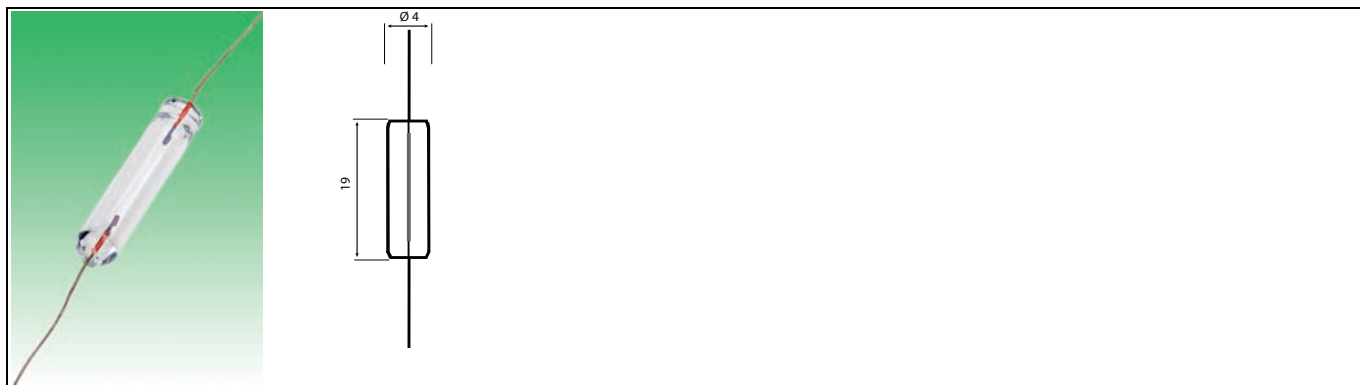

Numéro d'article	Voltage	Courant (A)	Filament	Teinte	V (h)	Flux (lm)	Code US
WA04030601	3	0.060	C-8	Clair	1000	0.8	
WA04060501	6	0.050	C-8	Clair	15000	1.2	
WA04090501	9	0.050	C-8	Clair	2000	1.5	
WA04120501	12	0.050	C-8	Clair	2000	2.0	

# Micro-lampes à fils isolés

## T1 1/4

### 4X12mm

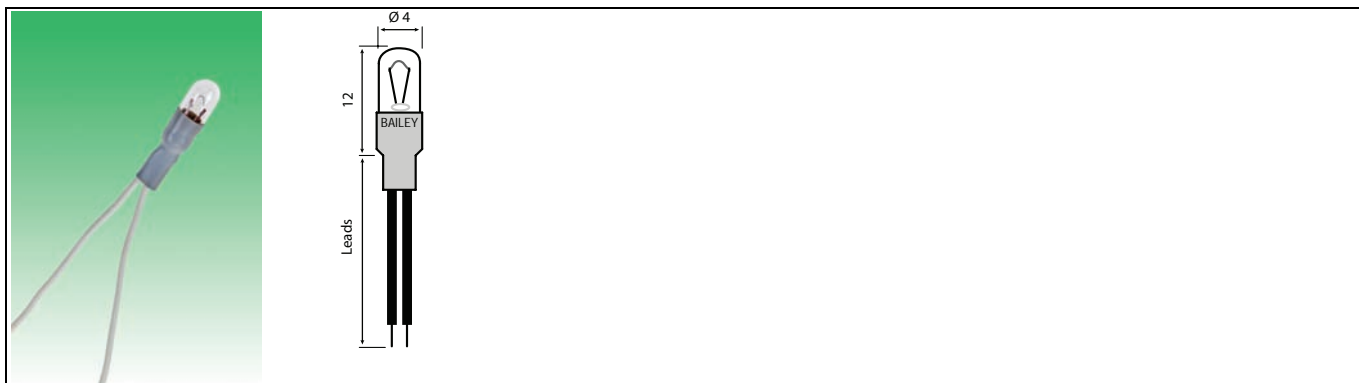

Numéro d'article	Voltage	Courant (A)	Filament	Teinte	Durée de vie (h)	Longueur fils (mm)	Code US
WP04040601	4.5	0.060	C-2R	Clair	10000	200	
WP04060402	6	0.040	C-2R	Clair	10000	250	
WP04060601	6	0.060	C-2R	Clair	10000	200	
WP04060603	6	0.060	C-2R	Clair	10000	300	
WP04060251	6.3	0.025	C-2R	Clair	10000	200	
WP04060401	6.3	0.040	C-2R	Clair	10000	200	
WP04060403	6.3	0.040	C-2R	Clair	10000	300	
WP04060801	6.3	0.080	C-2R	Clair	10000	200	
WP04080401	8	0.040	C-2R	Clair	10000	200	
WP04080402	8	0.040	C-2R	Clair	10000	250	
WP04080403	8	0.040	C-2R	Clair	10000	300	
WP04080601	8	0.060	C-2R	Clair	10000	200	
WP04080603	8	0.060	C-2R	Clair	10000	300	
WP04080801	8	0.080	C-2R	Clair	10000	200	
WP04080803	8	0.080	C-2R	Clair	10000	300	
WP04120401	12	0.040	C-2V	Clair	10000	200	
WP04120402	12	0.040	C-2V	Clair	10000	250	
WP04120403	12	0.040	C-2V	Clair	10000	300	
WP04120601	12	0.060	C-2V	Clair	10000	200	
WP04120603	12	0.060	C-2V	Clair	10000	300	
WP04140401	14	0.040	C-2F	Clair	10000	200	
WP04140402	14	0.040	C-2F	Clair	10000	250	
WP04140403	14	0.040	C-2F	Clair	10000	300	
WP04140803	14	0.080	C-2F	Clair	10000	300	
WP04240401	24	0.040	C-2F	Clair	10000	200	

## Bi-Pin

### T1

3.2X9.5mm Pin entraxe 1.27mm

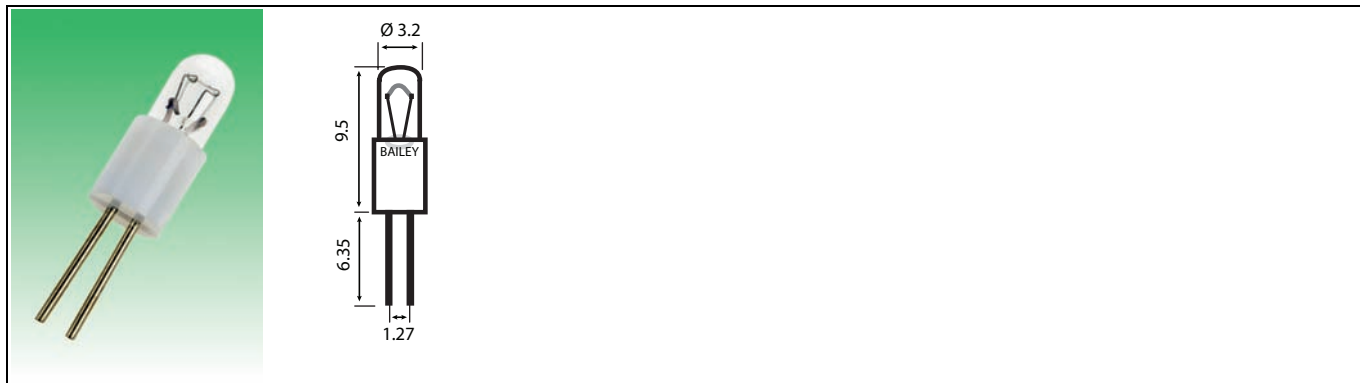

Numéro d'article	Voltage	Courant (A)	Filament	Teinte	Durée de vie (h)	mscp	Code US
BP13022001	2.5	0.200	C-2R	Clair	600	0.190	
BP13050601	5	0.060	C-2R	Clair	25000	0.050	7683
BP13050751	5	0.075	C-2R	Clair	60000	0.090	7714
BP13051151	5	0.115	C-2R	Clair	40000	0.150	7715
BP13060751	6	0.075	C-2R	Clair	5000		
BP13120301	12	0.030	C-2F	Clair	10000	0.100	
BP13120601	12	0.060	C-2V	Clair	16000	0.150	8097
BP13140651	14	0.065	C-2F	Clair	10000	0.150	
BP13280241	28	0.024	CC-2F	Clair	16000	0.150	7839
BP13280401	28	0.040	CC-2F	Clair	10000	0.360	

## Bi-Pin

### T1

3.2X9.5mm Pin entraxe 2.54mm



Numéro d'article	Voltage	Courant (A)	Filament	Teinte	V (h)	mscp	Code US
BP23050601	5	0.060	C-2R	Clair	25000	0.050	7683
BP23050751	5	0.075	C-2R	Clair	60000	0.090	
BP23061151	6	0.115	C-2R	Clair	40000	0.150	
BP23120501	12	0.050	C-2V	Clair	10000	0.150	
BP23120601	12	0.060	C-2F	Clair	16000	0.150	8097
BP23140651	14	0.065	C-2F	Clair	16000	0.150	
BP23180261	18	0.026	C-2F	Clair	16000	0.150	8099
BP23240201	24	0.020	CC-2F	Clair	16000	0.065	
BP23240241	24	0.024	CC-2F	Clair	16000	0.150	
BP23280241	28	0.024	CC-2F	Clair	16000	0.150	7839
BP23280401	28	0.040	CC-2F	Clair	7000	0.300	
BP23300201	30	0.020	CC-2F	Clair	5000	0.060	
BP23360201	36	0.020	CC-2F	Clair	10000	0.080	

## Bi-Pin

### T1

3.2X10mm Pin entraxe 3.17mm



Numéro d'article	Voltage	Courant (A)	Filament	Teinte	V (h)	mscp	Code US
BP33050601	5	0.060	C-2R	Clair	25000	0.050	
BP33050751	5	0.075	C-2R	Clair	25000	0.090	
BP33120401	12	0.040	C-2V	Clair	10000	0.090	
BP33120601	12	0.060	C-2V	Clair	16000	0.150	
BP33180261	18	0.026	CC-2F	Clair	16000	0.150	
BP33240201	24	0.020	CC-2F	Clair	16000	0.060	
BP33280241	28	0.024	CC-2F	Clair	16000	0.150	

## Bi-Pin

### T1 Spéciale

3.2X9.5mm Pin entraxe 1.27mm

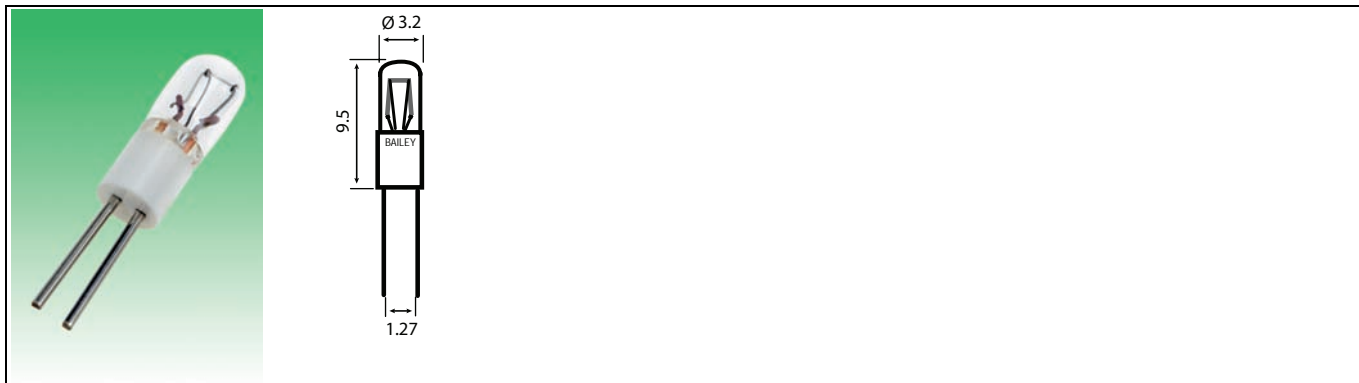

Numéro d'article	Voltage	Courant (A)	Filament	Teinte	Durée de vie (h)	mscp	Code US
BP137714	5	0.075	C-2R	Clair	25000	0.090	7714 SPECIAL
BP138097	12	0.060	C-2F	Clair	10000	0.150	8097 SPECIAL
BP137839	28	0.024	C-2F	Clair	16000	0.150	7839 SPECIAL

## Bi-Pin

### T1 1/4

4.5X14mm Pin entraxe 2.54mm

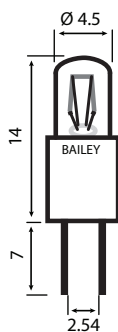

Numéro d'article	Voltage	Courant (A)	Filament	Teinte	Durée de vie (h)	mscp	Code US
BP24050601	5	0.060	C-2R	Clair	25000	0.050	7583
BP24060601	6	0.060	C-2V	Clair	25000	0.050	4015
BP24060602	6	0.060	C-2R	Clair	3000	0.130	7309
BP24062001	6.3	0.200	C-2R	Clair	5000	0.550	7310
BP24120401	12	0.040	C-2V	Clair	10000	0.120	4032
BP24120501	12	0.050	C-2V	Clair	10000	0.150	
BP24140801	14	0.080	C-2F	Clair	1000	0.500	7646
BP24160301	16	0.030	C-2F	Clair	10000	0.340	
BP24240351	24	0.035	C-2F	Clair	25000	0.130	4060
BP24280241	28	0.024	C-2F	Clair	10000	0.150	
BP24280251	28	0.025	C-2F	Clair	10000	0.080	619
BP24280401	28	0.040	C-2F	Clair	4000	0.340	7632
BP24360201	36	0.020	CC-2F	Clair	5000	0.080	
BP24480251	48	0.025	CC-2F	Clair	5000	0.200	7590

## Bi-Pin

### T1 3/4

5.7X16mm Pin entraxe 3.17mm

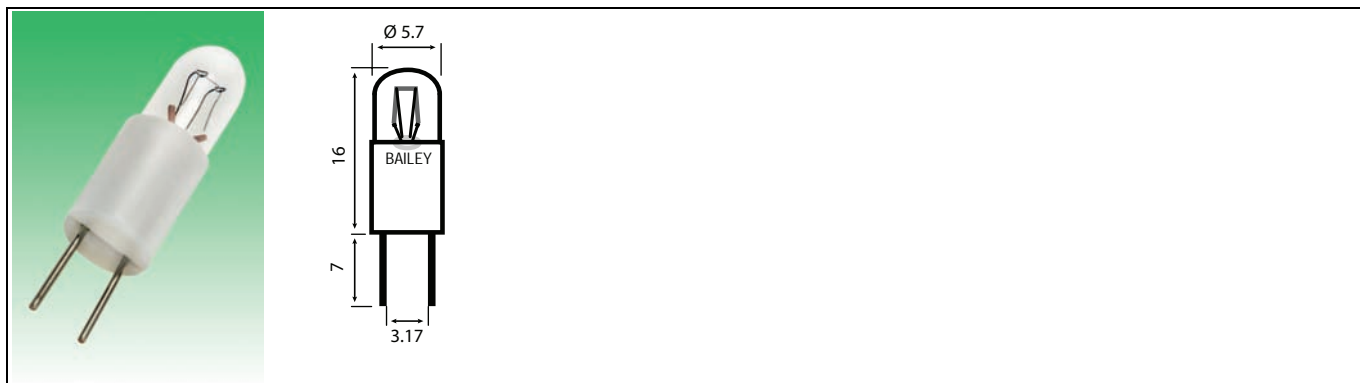

Numéro d'article	Voltage	Courant (A)	Filament	Teinte	Durée de vie (h)	mscp	Code US
BP36022001	2.5	0.200	C-2R	Clair	3000	0.250	7968
BP36023501	2.5	0.350	C-2R	Clair	10000	0.210	7868
BP36030151	3	0.015	C-6	Clair	10000	0.003	7375
BP36031901	3	0.190	C-2R	Clair	350		
BP36050601	5	0.060	C-2R	Clair	25000	0.050	7361
BP36051151	5	0.115	C-2R	Clair	40000	0.150	7362
BP36060401	6	0.040	C-2V	Clair	10000	0.040	7945
BP36062001	6	0.200	C-2R	Clair	50000	0.400	
BP36062002	6	0.200	C-2R	Clair	1000	0.340	7328
BP36060402	6.3	0.040	C-2V	Clair	10000	0.030	7380
BP36060751	6.3	0.075	C-2V	Clair	3000	0.150	7377
BP36062003	6.3	0.200	C-2R	Clair	5000	0.550	7349
BP3606200F	6.3	0.200	C-2R	Dépolie	5000		
BP36100401	10	0.040	C-2F	Clair	5000	0.080	7367
BP36120401	12	0.040	C-2F	Clair	10000	0.100	7371
BP36120601	12	0.060	C-2V	Clair	10000	0.160	
BP36140801	14	0.080	C-2F	Clair	15000	0.300	7382
BP36140802	14	0.080	C-2F	Clair	5000		7330
BP36180401	18	0.040	C-2F	Clair	10000	0.150	7370
BP36240501	24	0.050	C-2F	Clair	1000	0.500	
BP36280241	28	0.024	C-2F	Clair	4000	0.150	
BP36280351	28	0.035	C-2F	Clair	30000	0.100	
BP36280401	28	0.040	C-2F	Clair	7000	0.300	7387
BP36280402	28	0.040	C-2F	Clair	4000	0.340	7327
BP36280601	28	0.060	C-2F	Clair	25000	0.340	7876
BP36480251	48	0.025	CC-2F	Clair	5000	0.200	7748
BP36600201	60	0.020	CC-2F	Clair	5000	0.150	

**Bi-Pin**  
**Terasaki**  
**6X20mm**



Numéro d'article	Voltage	Courant (A)	Filament	Teinte	Durée de vie (h)	mscp	Code US
TERASAKI2824	28	0.024	CC-2F	Clair	16000	0.150	
TERASAKI2840	28	0.040	C-2F	Clair	7000	0.300	

## Midget Flanged

T3/4

2.5X9.5mm

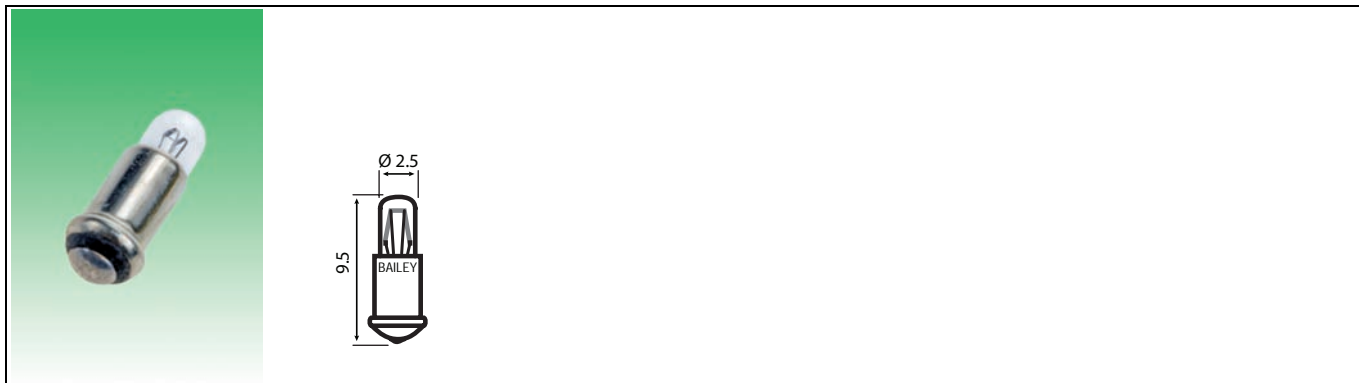

Numéro d'article	Voltage	Courant (A)	Filament	Teinte	Durée de vie (h)	mscp	Code US
MF02020501	2	0.050	C-2R	Clair	1000	0.030	
MF02050601	5	0.060	C-2R	Clair	25000	0.050	
MF02051151	5	0.115	C-2R	Clair	40000	0.150	
MF02060501	6	0.050	C-2R	Clair	5000	0.040	
MF02120501	12	0.050	C-2F	Clair	15000	0.070	
MF02140301	14	0.030	C-2F	Clair	15000	0.018	
MF02160301	16	0.030	C-2F	Clair	15000	0.020	
MF02240201	24	0.020	CC-2F	Clair	5000	0.035	
MF02280201	28	0.020	CC-2F	Clair	5000	0.050	

# Midget Flanged T1 Norme US 3.2X9.5mm

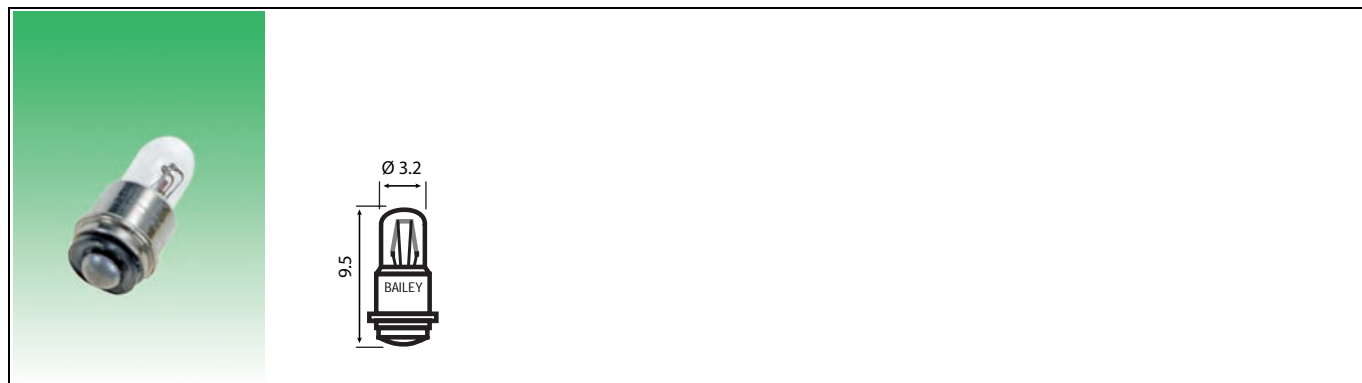

Numéro d'article	Voltage	Courant (A)	Filament	Teinte	Durée de vie (h)	MSCP	Code US
MF03010751	1.5	0.075	C-2R	Clair	16000	0.030	8102
MF03050211	5	0.021	C-2V	Clair	10000	0.034	8022
MF03050301	5	0.030	C-2R	Clair	16000	0.030	
MF03050601	5	0.060	C-2R	Clair	25000	0.050	685
MF03050751	5	0.075	C-2R	Clair	25000	0.090	714
MF03051151	5	0.115	C-2R	Clair	40000	0.150	718
MF03060401	6	0.040	C-2R	Clair	10000	0.040	3094
MF03060701	6	0.070	C-2R	Clair	16000	0.120	
MF03120201	12	0.020	C-2F	Clair	10000	0.020	
MF03120301	12	0.030	C-2V	Clair	15000	0.030	3024
MF03120601	12	0.060	C-2V	Clair	16000	0.150	32
MF03140401	14	0.040	C-2F	Clair	16000		
MF03140651	14	0.065	C-2F	Clair	16000	0.150	8112
MF03180261	18	0.026	C-2F	Clair	16000	0.150	7241
MF03240201	24	0.020	CC-2F	Clair	20000	0.090	
MF03240241	24	0.024	CC-2F	Clair	10000		
MF03280201	28	0.020	CC-2F	Clair	10000	0.050	3092
MF03280241	28	0.024	CC-2F	Clair	16000	0.150	6839
MF03280401	28	0.040	CC-2F	Clair	10000		
MF03360201	36	0.020	CC-2F	Clair	10000	0.150	

**Midget Flanged  
T1 Norme française  
3.2X14mm**

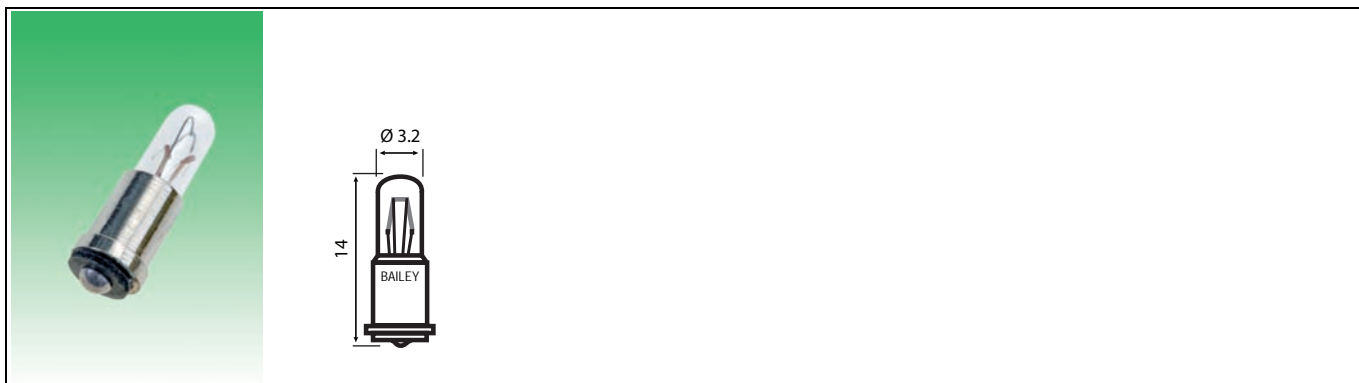

Numéro d'article	Voltage	Courant (A)	Filament	Teinte	Durée de vie (h)	mscp	Code US
MF14050601	5	0.060	C-2V	Clair	40000	0.050	172
MF14051151	5	0.115	C-2V	Clair	20000	0.150	173
MF14060701	6	0.070	C-2V	Clair	5000	0.090	174
MF14062001	6	0.200	C-2V	Clair	1000	0.500	175
MF14120201	12	0.020	C-2V	Clair	2000	0.040	194
MF14120301	12	0.030	C-2V	Clair	10000	0.500	
MF14120401	12	0.040	C-2F	Clair	1000	0.500	
MF14120601	12	0.060	C-2V	Clair	10000	0.150	177
MF14121001	12	0.100	C-2F	Clair	1000	0.300	178
MF14240201	24	0.020	CC-2F	Clair	20000	0.025	179
MF14280201	28	0.020	CC-2F	Clair	20000	0.060	
MF14280241	28	0.024	CC-2F	Clair	10000	0.080	180
MF14280401	28	0.040	CC-2F	Clair	1000	0.340	181

# Midget Flanged

T1 1/4

4.2X14mm



Numéro d'article	Voltage	Courant (A)	Filament	Teinte	Durée de vie (h)	mscp	Code US
MF0401060L	1.5	0.060	C-2R	Lentille	1	0.040	
MF0401090L	1.5	0.090	C-2R	Lentille	1	0.060	
MF04023001	2.5	0.300	C-2R	Clair	3000		
MF04024501	2.5	0.450	C-2R	Clair	1000	0.550	
MF04060401	6	0.040	C-2R	Clair	1000		8660
MF04120501	12	0.050	C-2F	Clair	25000	0.050	
MF04240401	24	0.040	C-2F	Clair	5000		
MF04280401	28	0.040	C-2F	Clair	10000	0.300	8632

# Midget Flanged

## T1 3/4

### 5.7X16mm

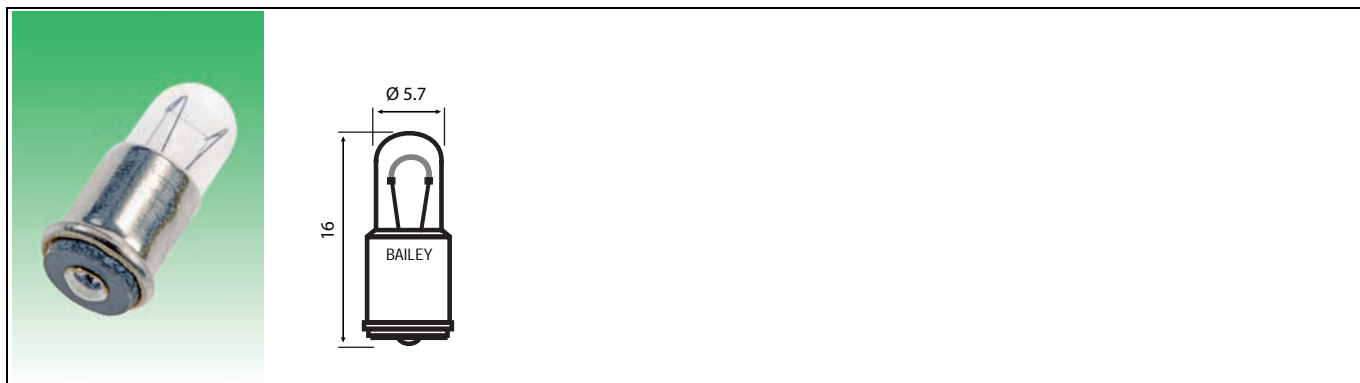

Numéro d'article	Voltage	Courant (A)	Filament	Teinte	Durée de vie (h)	mscp	Code US
MF06010601	1.35	0.060	C-6	Clair	3000	0.010	331
MF06022001	2.5	0.200	C-6	Clair	3000	0.250	368
MF06023001	2.5	0.300	C-6	Clair	3000		
MF06023501	2.5	0.350	C-2R	Clair	15000	0.200	268
MF06020601	2.7	0.060	C-6	Clair	6000	0.040	338
MF06030151	3	0.015	C-6	Clair	10000	0.003	375
MF06030301	3	0.030	C-2R	Clair	4000	0.020	329
MF06042501	4	0.250	C-2R	Clair	25000	0.200	
MF06050202	5	0.020	C-6	Clair	7000	0.015	
MF06050301	5	0.030	C-2R	Clair	10000	0.020	
MF06050602	5	0.060	C-2R	Clair	25000	0.050	7333
MF06051151	5	0.115	C-2R	Clair	35000	0.150	7335
MF06060401	6	0.040	C-2R	Clair	10000	0.040	345
MF06060601	6	0.060	C-2R	Clair	4000	0.130	
MF06060701	6	0.070	C-2V	Clair	15000	0.080	
MF06061001	6	0.100	C-2R	Clair	10000	0.120	
MF06062001	6	0.200	C-2R	Clair	2000	0.600	328
MF06060402	6.3	0.040	C-2R	Clair	30000	0.020	380
MF06060751	6.3	0.075	C-2R	Clair	1000	0.230	377
MF06062002	6.3	0.200	C-2R	Clair	30000	0.400	381
MF06062003	6.3	0.200	C-2R	Clair	5000	0.550	349
MF06100151	10	0.015	C-2F	Clair	50000	0.003	344
MF06100401	10	0.040	C-2F	Clair	5000	0.080	367
MF06120201	12	0.020	C-2F	Clair	20000	0.007	
MF06120401	12	0.040	C-2V	Clair	10000	0.100	394
MF06120601	12	0.060	C-2V	Clair	16000	0.150	
MF06120751	12	0.075	C-2F	Clair	10000	0.200	
MF06121001	12	0.100	C-2F	Clair	8000	0.300	
MF06140401	14	0.040	C-2F	Clair	5000	0.150	

# Midget Flanged

## T1 3/4

5.7X16mm

Numéro d'article	Voltage	Courant (A)	Filament	Teinte	Durée de vie (h)	mscp	Code US
MF06140501	14	0.050	C-2F	Clair	15000	0.080	
MF06140801	14	0.080	C-2F	Clair	15000	0.300	382
MF06140802	14	0.080	C-2F	Clair	10000	0.300	
MF06140803	14	0.080	C-2F	Clair	2000	0.500	330
MF06180261	18	0.026	C-2F	Clair	6000		
MF06180401	18	0.040	C-2F	Clair	10000	0.150	370
MF06190401	19	0.040	C-2F	Clair	15000	0.100	
MF06240201	24	0.020	CC-2F	Clair	10000	0.030	
MF06240251	24	0.025	CC-2F	Clair	12000	0.070	
MF06240401	24	0.040	C-2F	Clair	7000	0.250	
MF06240501	24	0.050	C-2F	Clair	12000	0.180	
MF06240502	24	0.050	C-2F	Clair	2000	0.500	
MF06240601	24	0.060	C-2F	Clair	1000	0.200	
MF06240801	24	0.080	C-2F	Clair	8000	0.500	
MF06280241	28	0.024	C-2F	Clair	6000	0.150	
MF06280251	28	0.025	C-2F	Clair	15000	0.080	
MF06280301	28	0.030	C-2F	Clair	6000	0.200	
MF06280401	28	0.040	C-2F	Clair	30000	0.150	
MF06280402	28	0.040	C-2F	Clair	10000	0.200	385
MF06280403	28	0.040	C-2F	Clair	8000	0.300	387
MF06280404	28	0.040	C-2F	Clair	5000	0.340	327
MF06280601	28	0.060	C-2F	Clair	12000	0.340	376
MF06280801	28	0.080	C-2F	Clair	6000	0.720	
MF06320331	32	0.033	CC-2F	Clair	3000	0.340	
MF06360201	36	0.020	CC-2F	Clair	12000	0.080	
MF06360301	36	0.030	C-2F	Clair	3000	0.300	
MF06360401	36	0.040	C-2F	Clair	3000		
MF06480201	48	0.020	CC-2F	Clair	4000	0.200	
MF06480251	48	0.025	CC-2F	Clair	5000	0.200	
MF06480301	48	0.030	CC-2F	Clair	6000	0.250	
MF06480401	48	0.040	CC-2F	Clair	5000	0.340	
MF06600201	60	0.020	CC-2F	Clair	5000	0.150	
MF06600301	60	0.030	CC-2F	Clair	1000	0.600	

# Midget Grooved

## T1 3/4

### 5.7X16mm

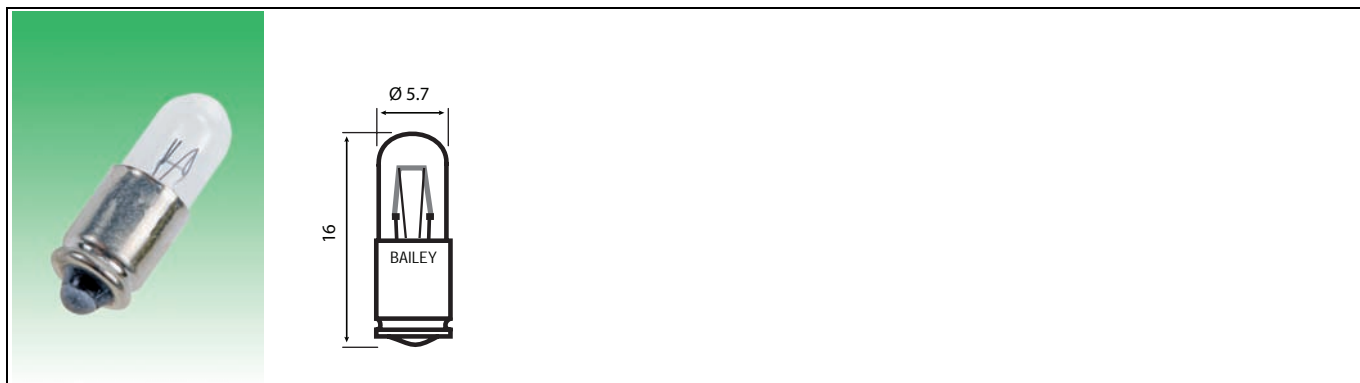

Numéro d'article	Voltage	Courant (A)	Filament	Teinte	Durée de vie (h)	mscp	Code US
MG06010601	1.35	0.060	C-6	Clair	3000	0.010	698
MG06023501	2.5	0.350	C-2R	Clair	10000	0.210	266
MG0602350L	2.5	0.350	C-2R	Lens	10000	0.200	253
MG06020601	2.7	0.060	C-6	Clair	6000	0.040	8704
MG06050401	5	0.040	C-2R	Clair	25000	0.025	
MG06050602	5	0.060	C-2R	Clair	25000	0.050	7347
MG06060401	6	0.040	C-2R	Clair	25000	0.030	8705
MG06060601	6	0.060	C-2R	Clair	4000	0.130	
MG06061251	6	0.125	C-2R	Clair	5000	0.350	
MG06062001	6	0.200	C-2R	Clair	2000	0.600	337
MG06060402	6.3	0.040	C-2R	Clair	30000	0.020	7351
MG06060751	6.3	0.075	C-2R	Clair	1000	0.230	8708
MG06061502	6.3	0.150	C-2R	Clair	2000	0.500	7352
MG06062002	6.3	0.200	C-2R	Clair	20000	0.400	379
MG06062003	6.3	0.200	C-2R	Clair	5000	0.550	398
MG06100151	10	0.015	C-2F	Clair	50000	0.003	709
MG06100401	10	0.040	C-2F	Clair	5000	0.080	397
MG06120201	12	0.020	C-2F	Clair	20000	0.007	
MG06120401	12	0.040	C-2F	Clair	10000	0.100	7354
MG06120601	12	0.060	C-2F	Clair	16000	0.150	
MG06120751	12	0.075	C-2F	Clair	10000	0.200	
MG06121001	12	0.100	C-2F	Clair	8000	0.300	
MG06121201	12	0.120	C-2F	Clair	10000	0.250	
MG06140201	14	0.020	C-2F	Clair	15000		
MG06140501	14	0.050	C-2F	Clair	15000	0.080	
MG06140801	14	0.080	C-2F	Clair	15000	0.200	
MG06140802	14	0.080	C-2F	Clair	10000	0.300	386
MG06140803	14	0.080	C-2F	Clair	2000	0.500	336
MG06180401	18	0.040	C-2F	Clair	10000	0.150	

# Midget Grooved

## T1 3/4

### 5.7X16mm

Numéro d'article	Voltage	Courant (A)	Filament	Teinte	Durée de vie (h)	mscp	Code US
MG06220401	22	0.040	C-2F	Clair	3000	0.300	457
MG06240201	24	0.020	CC-2F	Clair	10000	0.030	
MG06240251	24	0.025	C-2F	Clair	12000	0.070	
MG06240351	24	0.035	C-2F	Clair	10000	0.150	
MG06240401	24	0.040	C-2F	Clair	7000	0.250	
MG06240501	24	0.050	C-2F	Clair	12000	0.180	
MG06240601	24	0.060	C-2F	Clair	6000		
MG06240801	24	0.080	C-2F	Clair	8000	0.500	
MG06280201	28	0.020	C-2F	Clair	6000		
MG06280241	28	0.024	C-2F	Clair	6000	0.150	
MG06280251	28	0.025	C-2F	Clair	16000	0.080	
MG06280301	28	0.030	C-2F	Clair	6000	0.200	
MG06280302	28	0.030	C-2F	Clair	3000	0.250	
MG06280351	28	0.035	C-2F	Clair	15000	0.100	
MG06280401	28	0.040	C-2F	Clair	30000	0.150	
MG06280402	28	0.040	C-2F	Clair	10000	0.200	7355
MG06280403	28	0.040	C-2F	Clair	8000	0.300	388
MG06280404	28	0.040	C-2F	Clair	5000	0.340	334
MG06280601	28	0.060	C-2F	Clair	12000	0.340	334LSV
MG06280651	28	0.065	C-2F	Clair	6000	0.600	7356
MG06280801	28	0.080	C-2F	Clair	6000	0.720	
MG06300401	30	0.040	C-2F	Clair	5000	0.200	
MG06320331	32	0.033	C-2F	Clair	3000	0.340	
MG06360201	36	0.020	C-2F	Clair	12000	0.080	
MG06360301	36	0.030	CC-2F	Clair	3000	0.300	
MG06360401	36	0.040	C-2F	Clair	3000		
MG06480201	48	0.020	CC-2F	Clair	4000	0.200	
MG06480251	48	0.025	CC-2F	Clair	5000	0.200	
MG06480301	48	0.030	CC-2F	Clair	6000	0.150	
MG06480302	48	0.030	CC-2F	Clair	2500	0.300	
MG06480401	48	0.040	CC-2F	Clair	5000	0.340	
MG06600201	60	0.020	CC-2F	Clair	5000	0.150	6201
MG06600301	60	0.030	CC-2F	Clair	1000	0.600	
MG06700201	70	0.020	CC-2F	Clair	3000		

## Midget Trap

T1 3/4

6000hrs

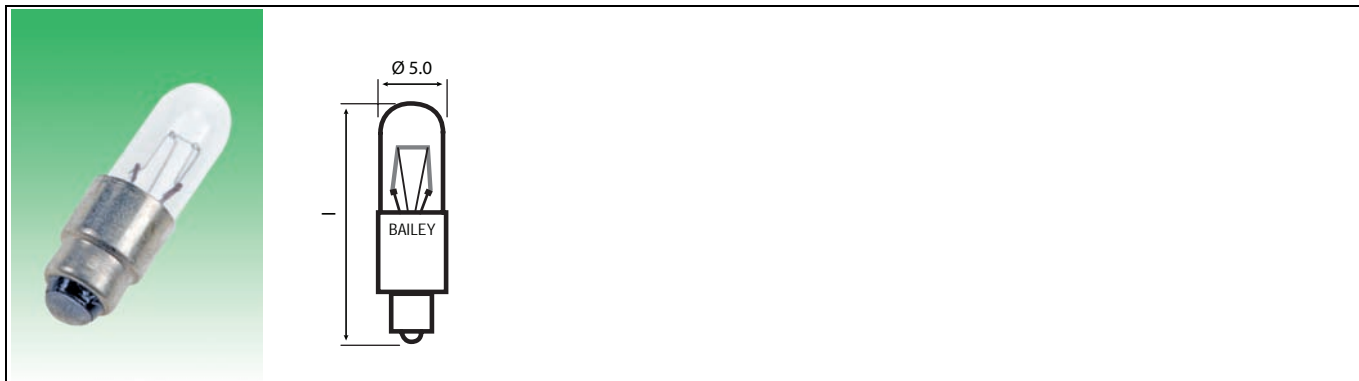

Numéro d'article	Voltage	Courant (A)	Filament	Teinte	Culot	V (h)	ø (mm)	l (mm)
MT18061001	6	0.100	C-2F	Clair	S5.5-K	10000	5	18
MT16062001	6.3	0.200	C-2F	Clair	S5.5-O	20000	5.7	16
MT18120501	12	0.050	C-2F	Clair	S5.5-K	10000	5	18
MT16140501	14	0.050	C-2F	Clair	S5.5-O	10000	5	16
MT16140801	14	0.080	C-2F	Clair	S5.5-O	15000	5.7	16
MT18180331	18	0.033	C-2F	Clair	S5.5-K	5000	5	18
MT16180501	18	0.050	C-2F	Clair	S5.5-O	5000	5	16
MT18240251	24	0.025	C-2F	Clair	S5.5-K	10000	5	18
MT16240501	24	0.050	C-2F	Clair	S5.5-O	2000	5.7	16
MT18280201	28	0.020	C-2F	Clair	S5.5-K	4000	5	18
MT16280211	28	0.021	C-2F	Clair	S5.5-O	2000	5.7	16
MT16280401	28	0.040	C-2F	Clair	S5.5-O	4000	5	16
MT16600201	60	0.020	CC-2F	Clair	S5.5-O	5000	5.7	16

# Midget Screw E5/8

## T1 3/4

### 5.7X17mm

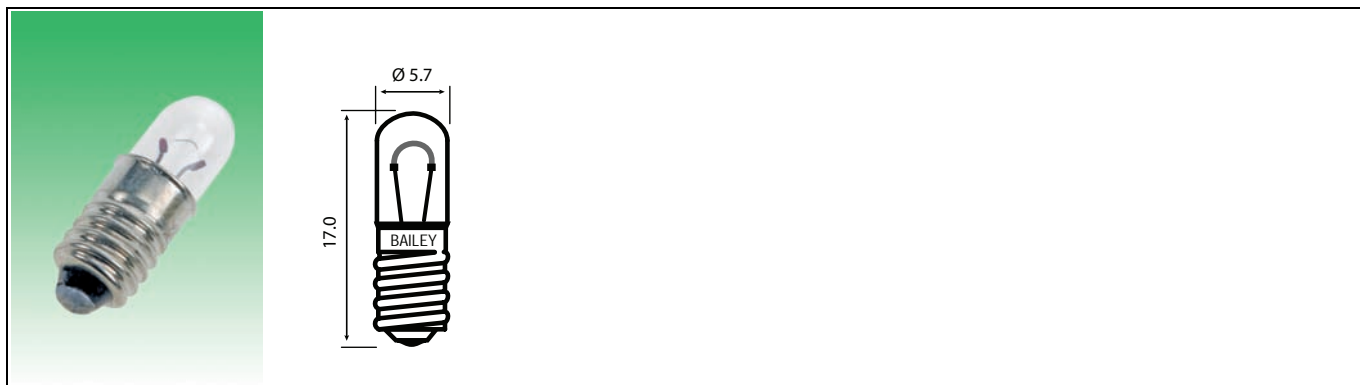

Numéro d'article	Voltage	Courant (A)	Filament	Teinte	Durée de vie (h)	mscp	Code US
MS06010601	1.35	0.060	C-6	Clair	500	0.010	8669
MS06010751	1.5	0.075	C-2R	Clair	30	0.040	
MS06011101	1.5	0.110	C-2R	Clair	1000	0.020	
MS06023001	2.5	0.300	C-2R	Clair	1000	0.200	
MS06023501	2.5	0.350	C-2R	Clair	15000	0.200	7312
MS06020601	2.7	0.060	C-2R	Clair	1000		
MS06022001	2.7	0.200	C-2R	Clair	1000	0.200	
MS06030151	3	0.015	C-6	Clair	10000	0.003	7313
MS06032001	3.5	0.200	C-2R	Clair	1000		
MS06043501	4	0.350	C-2R	Clair	250		
MS06040601	4.5	0.060	C-2R	Clair	1000	0.070	
MS06050601	5	0.060	C-2R	Clair	25000	0.050	7318
MS06051151	5	0.115	C-2R	Clair	40000	0.150	7319
MS06060401	6	0.040	C-2V	Clair	5000	0.040	342
MS06060501	6	0.050	C-2R	Clair	5000		
MS06060601	6	0.060	C-2R	Clair	5000	0.080	
MS06061001	6	0.100	C-2V	Clair	10000	0.160	
MS06062001	6	0.200	C-2V	Clair	1000	0.600	1768
MS06062002	6.3	0.200	C-2F	Clair	20000	0.400	378
MS06061501	6.5	0.150	C-2R	Clair	1000	0.500	
MS06081501	8	0.150	C-2R	Clair	1000	0.500	
MS06100151	10	0.015	C-2F	Clair	10000	0.006	8691
MS06120401	12	0.040	C-2F	Clair	5000	0.100	
MS06120501	12	0.050	C-2V	Clair	2000		
MS06120601	12	0.060	C-2V	Clair	5000	0.150	
MS06120801	12	0.080	C-2V	Clair	5000	0.160	
MS06121001	12	0.100	C-2V	Clair	10000	0.320	
MS06121201	12	0.120	C-2V	Clair	1000	0.400	
MS06121271	12	0.127	C-2F	Clair	5000	0.420	280

## Midget Screw E5/8

T1 3/4

5.7X17mm

Numéro d'article	Voltage	Courant (A)	Filament	Teinte	Durée de vie (h)	mscp	Code US
MS06140201	14	0.020	C-2F	Clair	3000		
MS06140401	14	0.040	C-2F	Clair	5000	0.160	
MS06140501	14	0.050	C-2F	Clair	1000	0.240	5682
MS06140801	14	0.080	C-2F	Clair	10000	0.300	8362
MS06140802	14	0.080	C-2F	Clair	2500	0.500	373
MS06180401	18	0.040	C-2F	Clair	5000	0.150	
MS06240201	24	0.020	C-2F	Clair	8000	0.060	
MS06240351	24	0.035	C-2F	Clair	25000	0.150	
MS06240401	24	0.040	C-2F	Clair	10000	0.240	687
MS06240501	24	0.050	C-2F	Clair	1000	0.500	
MS06240601	24	0.060	C-2F	Clair	1000		
MS06240801	24	0.080	C-2F	Clair	5000	0.200	
MS06280251	28	0.025	C-2F	Clair	15000	0.080	
MS06280401	28	0.040	C-2F	Clair	7000	0.300	399
MS06280402	28	0.040	C-2F	Clair	4000	0.340	335
MS06280801	28	0.080	C-2F	Clair	6000		
MS06360201	36	0.020	C-2F	Clair	1000	0.080	
MS06480201	48	0.020	CC-2F	Clair	4000	0.200	
MS06600201	60	0.020	CC-2F	Clair	5000	0.150	

# Midget Bayonet

## T1 3/4

4.8X15.9mm

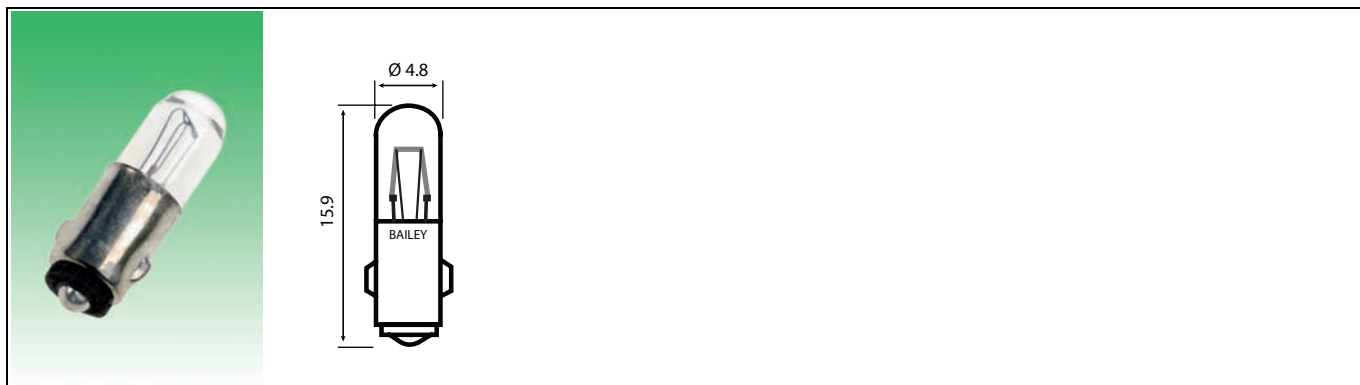

Numéro d'article	Voltage	Courant (A)	Filament	Teinte	Durée de vie (h)	mscp	Code US
MB16060401	6	0.040	C-2V	Clair	10000	0.030	
MB16062001	6	0.200	C-2R	Clair	2000	0.600	
MB16120401	12	0.040	C-2F	Clair	10000	0.120	
MB16140801	14	0.080	C-2F	Clair	15000	0.300	
MB16240201	24	0.020	C-2F	Clair	4000	0.150	
MB16240301	24	0.030	C-2F	Clair	4000	0.200	
MB16280401	28	0.040	C-2F	Clair	7000	0.300	
MB16280402	28	0.040	C-2F	Clair	4000	0.340	
MB16300401	30	0.040	C-2F	Clair	4000	0.300	
MB16320331	32	0.033	C-2F	Clair	5000	0.100	
MB16360251	36	0.025	CC-2F	Clair	5000	0.080	
MB16600201	60	0.020	CC-2F	Clair	5000	0.150	

# Culot Verre / Wedge

## T5

5X20mm W2X4.6D

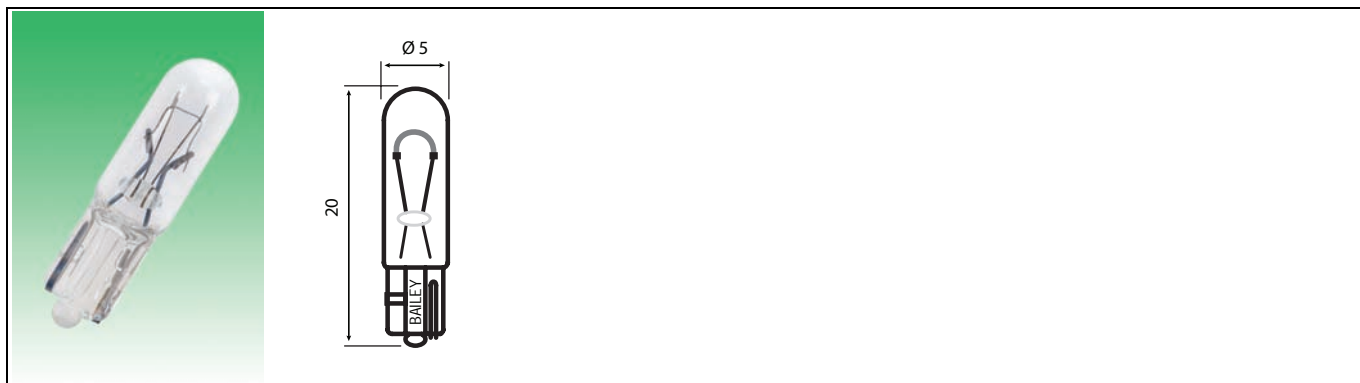

Numéro d'article	Voltage	Courant (A)	Wattage	Filament	Teinte	Durée de vie (h)	Code US
WB20060301	6	0.030	0.18	C-2V	Clair	5000	
WB20060801	6	0.080	0.48	C-2V	Clair	1000	
WB20061501	6	0.150	0.9	C-2R	Clair	2000	
WB20061671	6	0.167	1	C-2V	Clair	2000	
WB20062001	6	0.200	1.2	C-2V	Clair	10000	
WB20063331	6	0.333	2	C-2V	Clair	2000	
WB20060401	6.3	0.040	0.25	C-2V	Clair	10000	84
WB20120171	12	0.017	2	C-2V	Clair	2000	
WB20120301	12	0.030	0.36	C-2V	Clair	5000	
WB20120801	12	0.080	1	C-2V	Clair	10000	
WB20121001	12	0.100	1.2	C-2V	Clair	10000	
WB20121651	12	0.165	2	C-2V	Clair	1000	
WB20121921	12	0.192	2.3	C-2V	Clair	2000	
WB20140801	14	0.080	1.12	C-2F	Clair	15000	73
WB20140802	14	0.080	1.12	C-2V	Clair	15000	73
WB20141001	14	0.100	1.4	C-2V	Clair	1000	
WB20240301	24	0.030	0.72	C-2F	Clair	5000	
WB20240401	24	0.040	1	C-2F	Clair	10000	
WB20240501	24	0.050	1.2	C-2F	Clair	1000	
WB2024050R	24	0.050	1.2	C-2F	Rouge	1000	
WB20240801	24	0.080	2	C-2F	Clair	10000	
WB20280401	28	0.040	1.12	C-2F	Clair	10000	85

**Culot Verre / Wedge**  
**T5 Culot plastique**  
**5X20mm W2X4.6D**

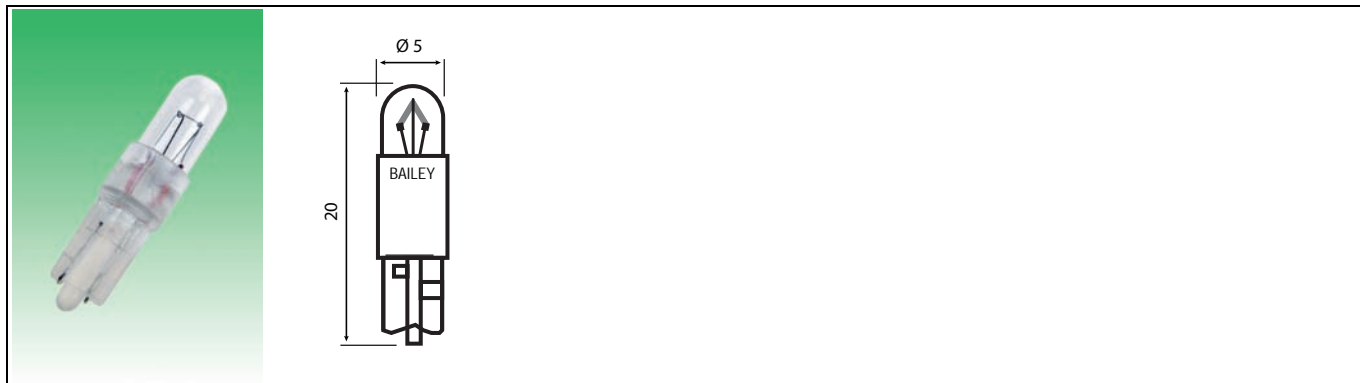

Numéro d'article	Voltage	Courant (A)	Wattage	Filament	Teinte	Durée de vie (h)	Code US
WR20060301	6	0.030	0.18	C-2V	Clair	10000	
WR20120831	12	0.083	1	C-2V	Clair	5000	
WR20140301	14	0.030	0.42	C-2V	Clair	10000	
WR20280301	28	0.030	0.84	C-2F	Clair	10000	
WR20480251	48	0.025	1.2	C-2F	Clair	1000	
WR20600201	60	0.020	1.2	C-2F	Clair	1000	

# Culot Verre / Wedge

## T10

10X26mm W2.1X9.5D

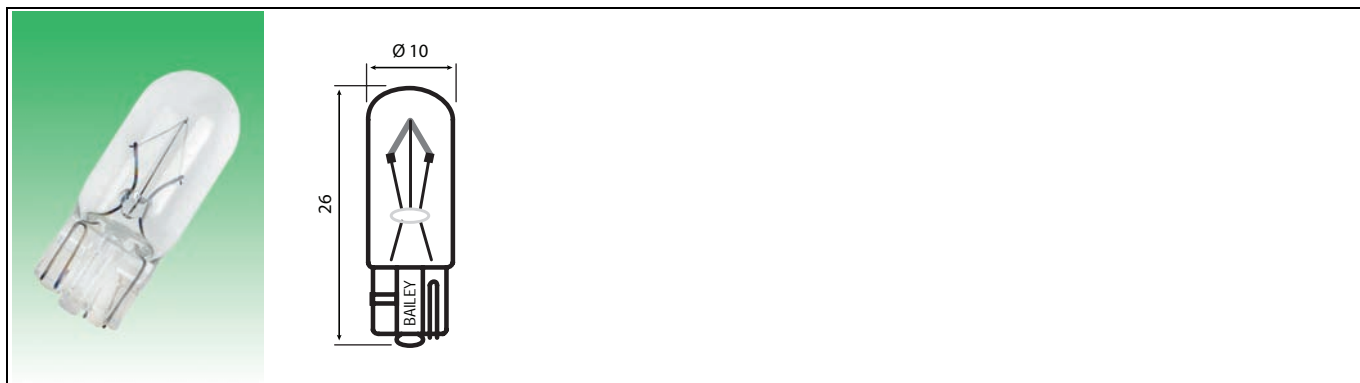

Numéro d'article	Voltage	Courant (A)	Wattage	Filament	Teinte	Durée de vie (h)	Code US
WB28061671	6	0.167	1	C-2V	Clair	5000	
WB28062001	6	0.200	1.2	C-2V	Clair	5000	
WB28063331	6	0.333	2	C-2V	Clair	5000	516
WB28065001	6	0.500	3	C-2V	Clair	5000	
WB28068301	6	0.830	5	C-2R	Clair	5000	
WB28061501	6.3	0.150	0.95	C-2R	Clair	10000	159
WB28062501	6.3	0.250	1.6	C-2R	Clair	10000	259
WB28063171	6.3	0.317	2	C-2V	Clair	10000	
WB28071001	7	0.100	0.7	C-2V	Clair	3000	
WB28121001	12	0.100	1.2	C-2V	Clair	5000	1112
WB28121251	12	0.125	1.5	C-2V	Clair	5000	
WB28121651	12	0.165	2	C-2V	Clair	2000	
WB28121831	12	0.183	2.2	C-2V	Clair	1000	
WB28122501	12	0.250	3	C-2V	Clair	5000	504
WB28124001	12	0.400	5	C-2V	Clair	2000	501
WB28140801	14	0.080	1.12	C-2F	Clair	15000	658
WB28141901	14	0.190	2.66	C-2F	Clair	1000	
WB28142401	14	0.240	3.36	C-2V	Clair	500	158
WB28142701	14	0.270	3.78	C-2V	Clair	1500	
WB2830002F	24-30		2	C-2V	Dépolie	2000	
WB28240801	24	0.080	2	C-2F	Clair	5000	
WB28241251	24	0.125	3	C-2F	Clair	5000	
WB28241651	24	0.165	4	C-2F	Clair	5000	
WB28242081	24	0.208	5	C-2F	Clair	500	
WB28280601	28	0.060	1.68	C-2F	Clair	10000	656
WB28281001	28	0.100	2.8	C-2F	Clair	1000	400
WB28282001	28	0.200	5.6	C-2F	Clair	7000	655
WB28320631	32	0.063	2	C-2F	Clair	2000	
WB28600401	48-60		2	C-2F	Clair	2000	

# Culot Verre / Wedge

## T10 Xénon

10X26mm W2.1X9.5D

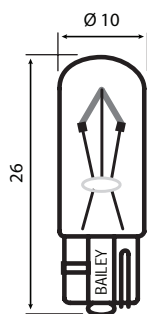

### Fiche produit:

Les wedge au xénon, contrairement à d'autres lampes wedge, sont conçues pour répondre aux besoins des applications d'éclairage général. Les défauts de la lampe wedge traditionnelle utilisée dans l'éclairage général (durée de vie de la lampe, température de couleur, de chaleur et de sécurité) ont été améliorés. Les lampes wedge au xénon sont ainsi idéales pour les applications d'éclairage de marches d'escaliers, de rampes, résidentiel, cabinet et l'éclairage vitrine.

Numéro d'article	Voltage	Courant (A)	Wattage	Filament	Teinte	Durée de vie (h)	Flux lumineux (lm)
XWB28122501	12	0.250	3	C-2V	Clair	20000	22.0
XWB28122501F	12	0.250	3	C-2V	Dépolie	20000	22.0
XWB28124171	12	0.417	5	C-2V	Clair	8000	33.0
XWB28124171F	12	0.417	5	C-2V	Dépolie	8000	33.0
XWB28124172	12	0.417	5	C-2V	Clair	2000	50.2
XWB28124172F	12	0.417	5	C-2V	Dépolie	2000	50.2
XWB28125001	12	0.500	6	C-2V	Clair	1000	85.0
XWB28125001F	12	0.500	6	C-2V	Dépolie	1000	85.0
XWB28125831	12	0.583	7	C-2V	Clair	1000	82.0
XWB28125831F	12	0.583	7	C-2V	Dépolie	1000	82.0
XWB28242081	24	0.208	5	C-2V	Clair	10000	37.7
XWB28242081F	24	0.208	5	C-2V	Dépolie	10000	37.7
XWB28243131	24	0.313	7.5	C-2V	Clair	10000	65.3
XWB28243131F	24	0.313	7.5	C-2V	Dépolie	10000	65.3
XWB28244171	24	0.417	10	C-2V	Clair	10000	90.4
XWB28244171F	24	0.417	10	C-2V	Dépolie	10000	90.4
XWB28282001	28	0.200	5.6	C-2F	Clair	7000	37.7
XWB28282001F	28	0.200	5.6	C-2F	Dépolie	7000	37.7

# Culot Verre / Wedge

## T15

15X36mm W2.1X9.5D

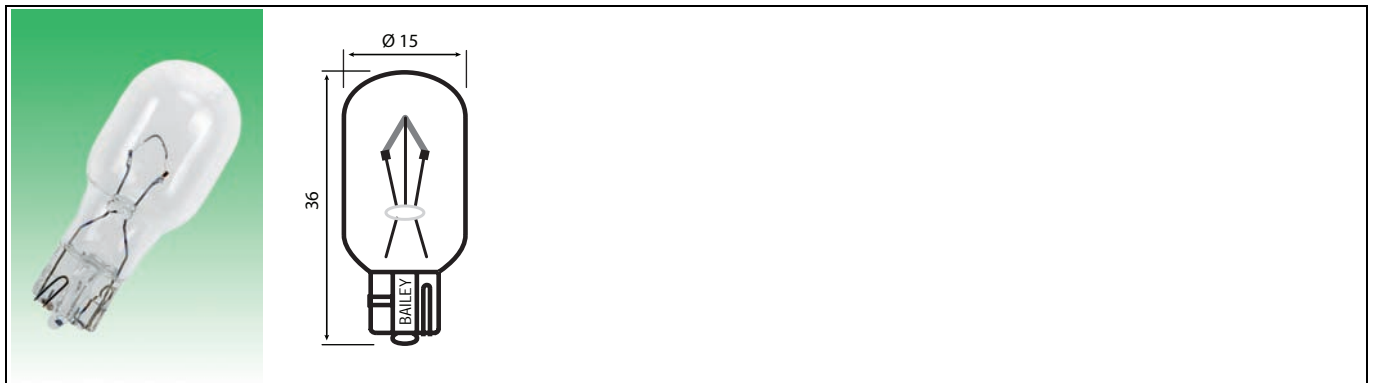

Numéro d'article	Voltage	Courant (A)	Wattage	Filament	Teinte	Durée de vie (h)	Code US
WB35060900	6	0.900	5.4	C-2R	Clair	200	939
WB35061200	6	1.200	7.2	C-2R	Clair	200	927
WB35120417	12	0.417	5	C-2R	Clair	1000	
WB35120583	12	0.583	7	C-2R	Clair	1000	
WB35120667	12	0.667	8	C-2R	Clair	1000	
WB35120833	12	0.833	10	C-2R	Clair	500	923
WB35121250	12	1.250	15	C-2R	Clair	1200	917
WB35121500	12	1.500	18	C-2R	Clair	1000	
WB35121667	12	1.667	20	C-2R	Clair	1000	925
WB35121750	12	1.750	21	C-2R	Clair	1000	
WB35121000	12.8	1.000	12	C-2R	Clair	1000	912
WB35130690	13	0.690	9	C-2R	Clair	1000	906
WB35240208	24	0.208	5	C-2R	Clair	1000	
WB35240292	24	0.292	7.2	C-2R	Clair	1000	
WB35240417	24	0.417	10	C-2R	Clair	1000	
WB35240625	24	0.625	15	C-2R	Clair	1000	
WB35240875	24	0.875	21	C-2R	Clair	1000	

# Culot Verre / Wedge Neo-Wedge support plastique

T1 - T1 1/4 - T1 1/2

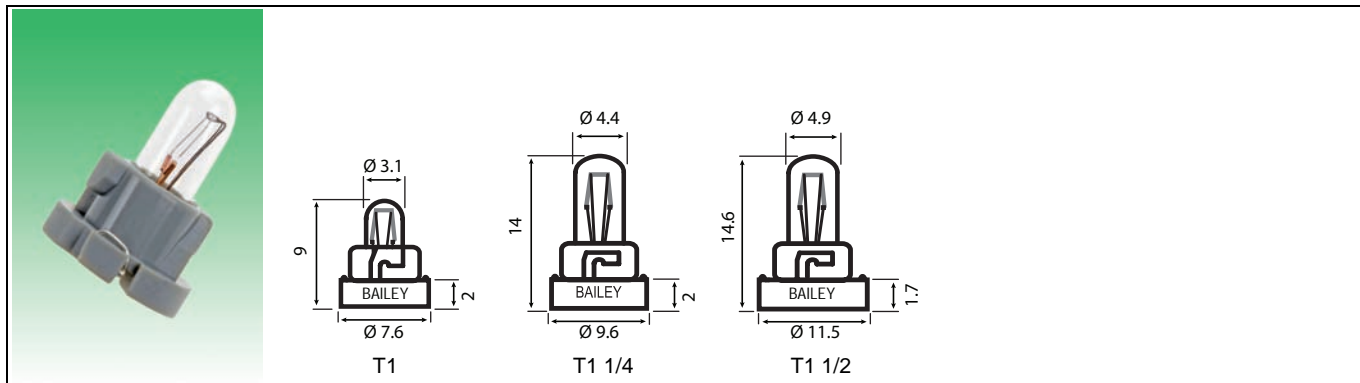

Numéro d'article	Voltage	Courant (A)	Filament	Teinte	ø (mm)	l (mm)	Couleur
WN03120602	12	0.060	C-2F	Clair	7.6	9	Noir
WN04120402	12	0.040	C-2F	Clair	9.6	14	Gris
WN04121002	12	0.100	C-2F	Clair	9.6	14	Gris
WN04280402	28	0.040	C-2F	Clair	9.6	14	Gris
WN05141004	14	0.100	C-2F	Clair	11.5	14.6	Gris
WN05240402	24	0.040	C-2F	Clair	11.5	14.6	Gris

# Lampes Téléphoniques

## T4.5

4X16mm

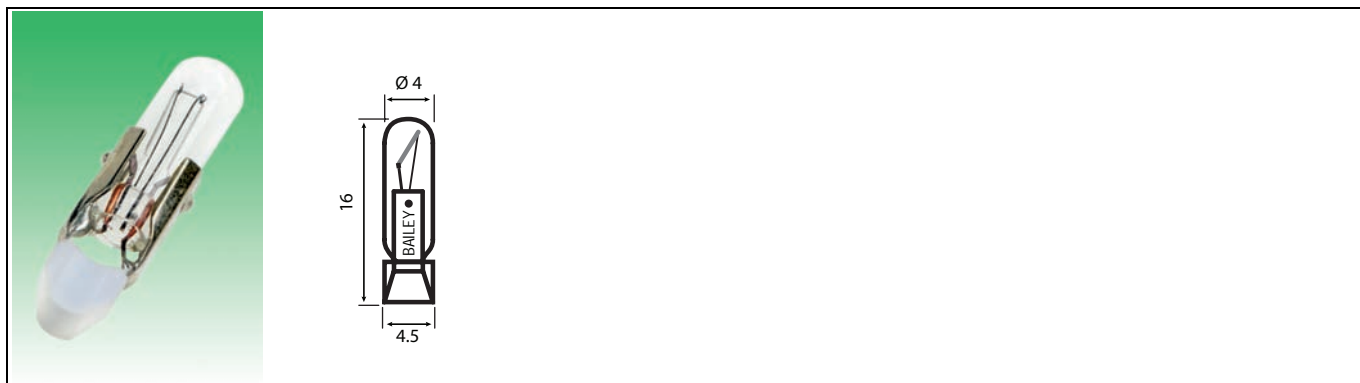

Numéro d'article	Voltage	Courant (A)	Filament	Teinte	Durée de vie (h)
T4505120	5	0.120	C-2V	Clair	5000
T4506020	6	0.020	C-2V	Clair	10000
T4506040	6	0.040	C-2R	Clair	10000
T4506050	6	0.050	C-2R	Clair	5000
T4506070	6	0.070	C-2V	Clair	5000
T4506100	6	0.100	C-2V	Clair	5000
T4506200	6	0.200	C-2R	Clair	5000
T4512020	12	0.020	C-2V	Clair	10000
T4512040	12	0.040	C-2V	Clair	10000
T4512050	12	0.050	C-2V	Clair	10000
T4512100	12	0.100	C-2F	Clair	5000
T4518025	18	0.025	C-2F	Clair	5000
T4524020	24	0.020	C-2F	Clair	10000
T4524030	24	0.030	C-2F	Clair	10000
T4524040	24	0.040	C-2F	Clair	10000
T4524050	24	0.050	C-2F	Clair	10000
T4530020	30	0.020	C-2F	Clair	10000
T4530040	30	0.040	C-2F	Clair	10000
T4532033	32	0.033	C-2F	Clair	20000
T4536020	36	0.020	C-2F	Clair	10000
T4536035	36	0.035	C-2F	Clair	5000
T4548020	48	0.020	CC-2F	Clair	5000
T4548030	48	0.030	CC-2F	Clair	5000
T4548040	48	0.040	CC-2F	Clair	5000
T4560020	60	0.020	CC-2F	Clair	5000

# Lampes Téléphoniques

## T4.6

4X22mm

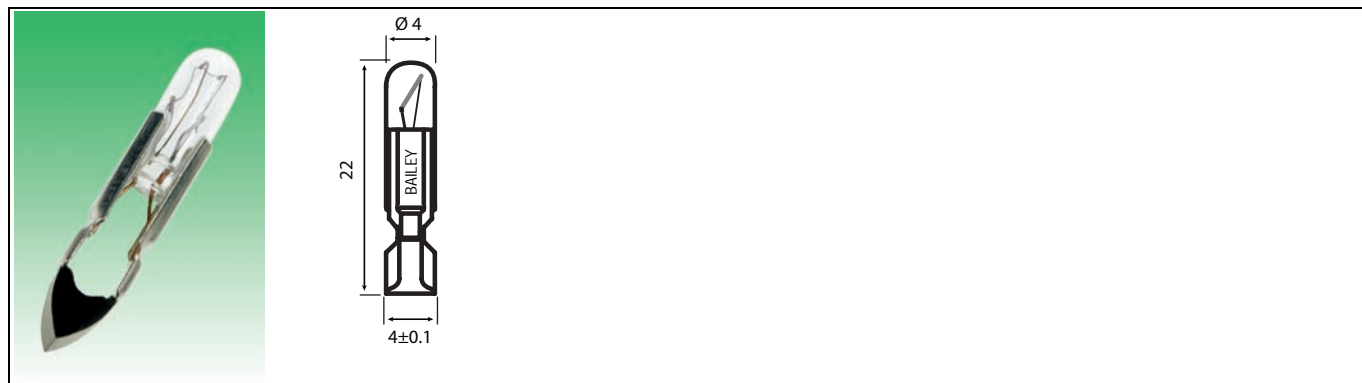

Numéro d'article	Voltage	Courant (A)	Filament	Teinte	Durée de vie (h)
T4606020	6	0.020	C-2V	Clair	10000
T4606040	6	0.040	C-2V	Clair	10000
T4606050	6	0.050	C-2V	Clair	5000
T4606100	6	0.100	C-2V	Clair	5000
T4606200	6	0.200	C-2R	Clair	5000
T4612020	12	0.020	C-2V	Clair	10000
T4612040	12	0.040	C-2V	Clair	10000
T4612050	12	0.050	C-2V	Clair	10000
T4612100	12	0.100	C-2F	Clair	5000
T4616060	16	0.060	C-2F	Clair	5000
T4618025	18	0.025	C-2F	Clair	5000
T4624020	24	0.020	C-2F	Clair	10000
T4624030	24	0.030	C-2F	Clair	10000
T4624040	24	0.040	C-2F	Clair	10000
T4624050	24	0.050	C-2F	Clair	10000
T4628020	28	0.020	C-2F	Clair	5000
T4628040	28	0.040	C-2F	Clair	5000
T4630020	30	0.020	C-2F	Clair	10000
T4630030	30	0.030	C-2F	Clair	5000
T4630040	30	0.040	C-2F	Clair	10000
T4632033	32	0.033	C-2F	Clair	20000
T4636020	36	0.020	C-2F	Clair	5000
T4636035	36	0.035	C-2F	Clair	5000
T4648020	48	0.020	CC-2F	Clair	5000
T4648030	48	0.030	CC-2F	Clair	5000
T4660020	60	0.020	CC-2F	Clair	5000
T4670020	70	0.020	CC-2F	Clair	5000

# Lampes Téléphoniques

## T5.5K

5X22mm

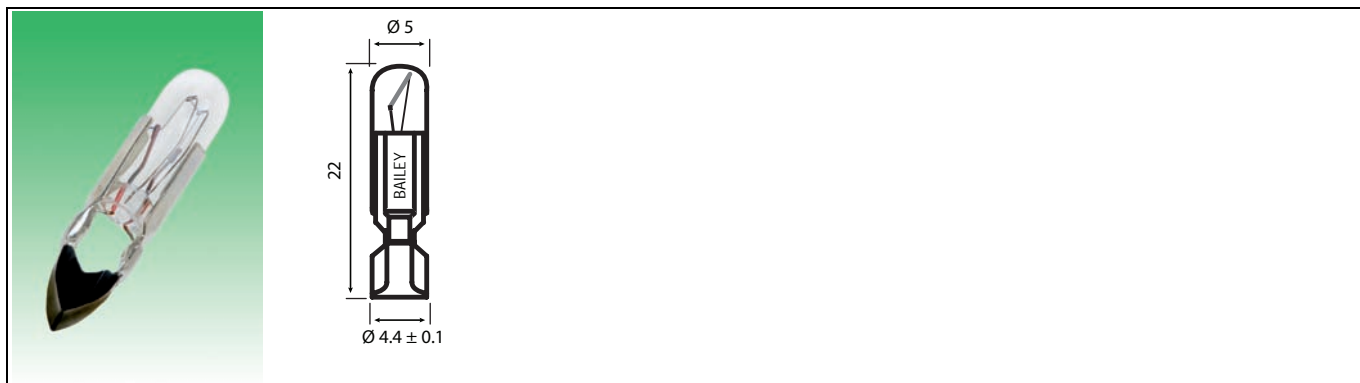

Numéro d'article	Voltage	Courant (A)	Filament	Teinte	Durée de vie (h)
T5606020	6	0.020	C-2V	Clair	10000
T5606040	6	0.040	C-2V	Clair	10000
T5606050	6	0.050	C-2V	Clair	5000
T5606100	6	0.100	CC-6	Clair	5000
T5606160	6	0.160	C-2V	Clair	5000
T5606200	6	0.200	C-2R	Clair	5000
T5612020	12	0.020	C-2V	Clair	10000
T5612040	12	0.040	C-2V	Clair	10000
T5612050	12	0.050	C-2F	Clair	10000
T5612100	12	0.100	C-2F	Clair	5000
T5616060	16	0.060	C-2F	Clair	5000
T5618025	18	0.025	C-2F	Clair	5000
T5624020	24	0.020	C-2F	Clair	10000
T5624030	24	0.030	C-2F	Clair	10000
T5624040	24	0.040	C-2F	Clair	10000
T5624050	24	0.050	C-2F	Clair	10000
T5624080	24	0.080	C-2F	Clair	5000
T5624100	24	0.100	C-2F	Clair	5000
T5626040	26	0.040	C-2F	Clair	10000
T5628040	28	0.040	C-2F	Clair	5000
T5628050	28	0.050	C-2F	Clair	10000
T5630020	30	0.020	C-2F	Clair	10000
T5630040	30	0.040	C-2F	Clair	10000
T5630050	30	0.050	C-2F	Clair	10000
T5632033	32	0.033	C-2F	Clair	10000
T5636020	36	0.020	C-2F	Clair	10000
T5636040	36	0.040	C-2F	Clair	10000
T5636050	36	0.050	CC-2F	Clair	5000
T5648020	48	0.020	CC-2F	Clair	5000
T5648025	48	0.025	CC-2F	Clair	5000

## Lampes Téléphoniques

### T5.5K

#### 5X22mm

Numéro d'article	Voltage	Courant (A)	Filament	Teinte	Durée de vie (h)
T5648030	48	0.030	CC-2F	Clair	5000
T5652020	52	0.020	CC-2F	Clair	5000
T5660020	60	0.020	CC-2F	Clair	5000
T5670020	70	0.020	CC-2F	Clair	5000

# Lampes Téléphoniques

## T5.5

5X30mm

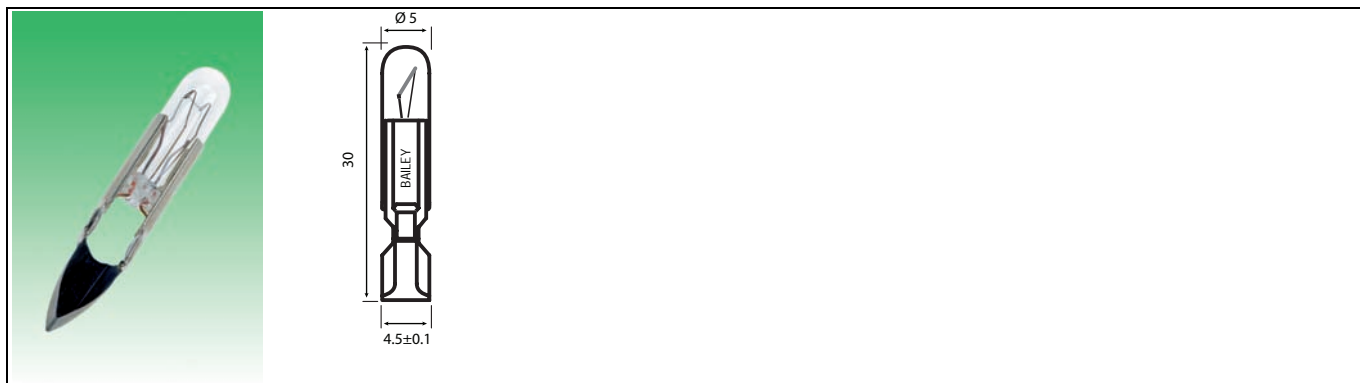

Numéro d'article	Voltage	Courant (A)	Filament	Teinte	Durée de vie (h)
T5506020	6	0.020	C-2V	Clair	10000
T5506040	6	0.040	C-2V	Clair	10000
T5506050	6	0.050	C-2V	Clair	5000
T5506080	6	0.080	C-2R	Clair	5000
T5506100	6	0.100	C-2R	Clair	5000
T5506200	6	0.200	C-2R	Clair	5000
T5512020	12	0.020	C-2V	Clair	10000
T5512040	12	0.040	C-2V	Clair	10000
T5512050	12	0.050	C-2V	Clair	10000
T5512080	12	0.080	C-2V	Clair	5000
T5512100	12	0.100	C-2F	Clair	5000
T5514020	14	0.020	C-2F	Clair	5000
T5516050	16	0.050	C-2F	Clair	5000
T5518025	18	0.025	C-2F	Clair	10000
T5518066	18	0.066	C-2F	Clair	5000
T5524020	24	0.020	C-2F	Clair	10000
T5524025	24	0.025	C-2F	Clair	5000
T5524030	24	0.030	C-2F	Clair	10000
T5524040	24	0.040	C-2F	Clair	10000
T5524050	24	0.050	C-2F	Clair	10000
T5524060	24	0.060	C-2F	Clair	5000
T5524080	24	0.080	C-2F	Clair	5000
T5526040	26	0.040	C-2F	Clair	5000
T5528020	28	0.020	C-2F	Clair	5000
T5528040	28	0.040	C-2F	Clair	10000
T5528050	28	0.050	C-2F	Clair	10000
T5530020	30	0.020	C-2F	Clair	10000
T5530030	30	0.030	C-2F	Clair	5000
T5530040	30	0.040	C-2F	Clair	10000
T5530050	30	0.050	C-2F	Clair	5000

## Lampes Téléphoniques

### T5.5

5X30mm

Numéro d'article	Voltage	Courant (A)	Filament	Teinte	Durée de vie (h)
T5530080	30	0.080	C-2F	Clair	5000
T5532033	32	0.033	C-2F	Clair	10000
T5536020	36	0.020	C-2F	Clair	10000
T5536030	36	0.030	C-2F	Clair	5000
T5536033	36	0.033	C-2F	Clair	5000
T5536035	36	0.035	C-2F	Clair	5000
T5536040	36	0.040	C-2F	Clair	5000
T5536050	36	0.050	C-2F	Clair	5000
T5540050	40	0.050	C-2F	Clair	5000
T5548020	48	0.020	CC-2F	Clair	5000
T5548025	48	0.025	CC-2F	Clair	5000
T5548030	48	0.030	CC-2F	Clair	5000
T5548040	48	0.040	CC-2F	Clair	5000
T5548050	48	0.050	CC-2F	Clair	5000
T5552020	52	0.020	CC-2F	Clair	5000
T5560020	60	0.020	CC-2F	Clair	5000
T5560030	60	0.030	CC-2F	Clair	5000
T5560040	60	0.040	CC-2F	Clair	5000
T5560050	60	0.050	CC-2F	Clair	5000
T5570020	70	0.020	CC-2F	Clair	5000
T5570040	70	0.040	CC-2F	Clair	5000
T5580020	80	0.020	CC-2F	Clair	5000

# Lampes Téléphoniques

## T5.5 EUBA Type BELL

5X30mm

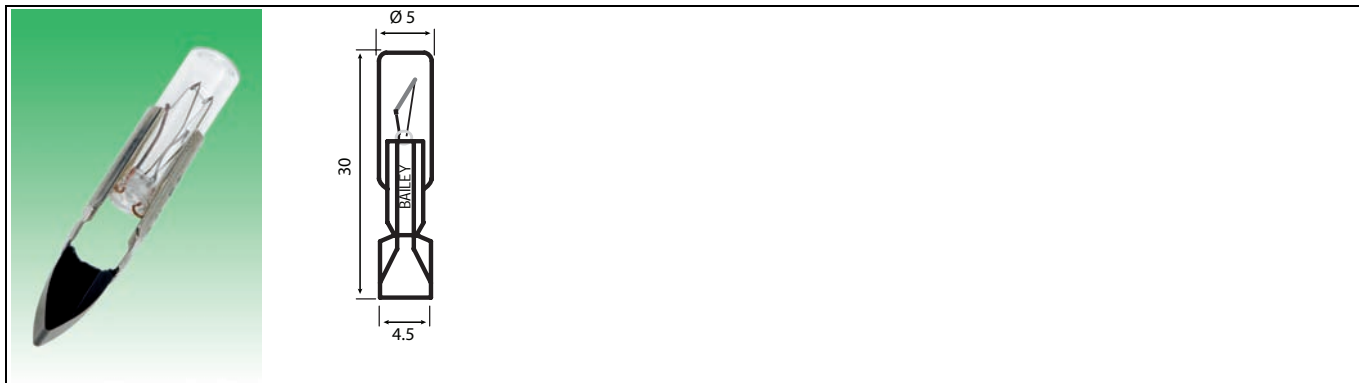

Numéro d'article	Voltage	Courant (A)	Filament	Teinte	Durée de vie (h)
T3006040	6	0.040	C-2V	Clair	3000
T3012050	12	0.050	C-2F	Clair	3000
T3024020	24	0.020	C-2F	Clair	3000
T3024050	24	0.050	C-2F	Clair	3000
T3048020	48	0.020	CC-2F	Clair	3000
T3048040	48	0.040	CC-2F	Clair	3000
T3060018	60	0.018	CC-2F	Clair	3000

# Lampes Téléphoniques

## T6.5F Culot français

### 6X44mm

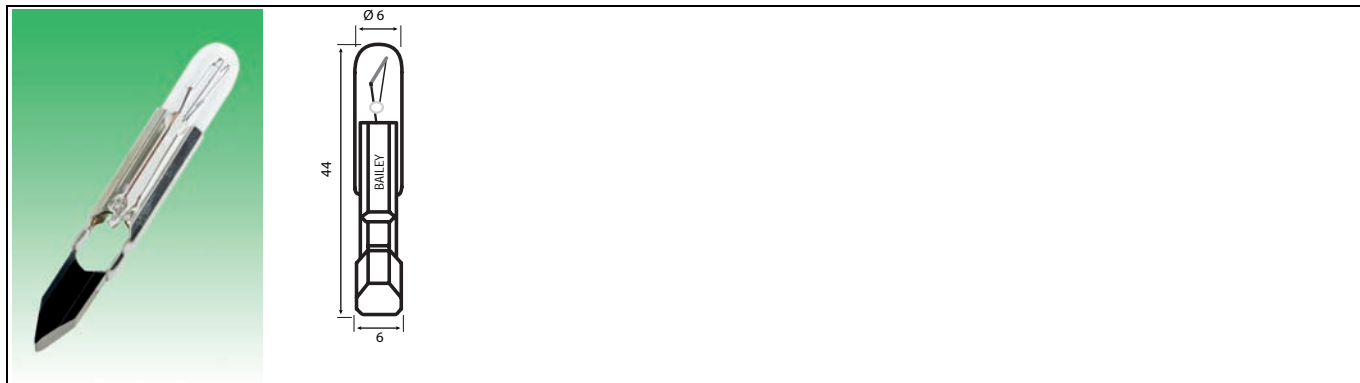

Numéro d'article	Voltage	Courant (A)	Filament	Teinte	Durée de vie (h)
T6506020	6	0.020	C-2V	Clair	5000
T6506040	6	0.040	C-2V	Clair	5000
T6506080	6	0.080	C-2R	Clair	5000
T6506100	6	0.100	C-2R	Clair	5000
T6506200	6	0.200	C-2R	Clair	5000
T6512020	12	0.020	C-2V	Clair	5000
T6512040	12	0.040	C-2V	Clair	5000
T6512050	12	0.050	C-2V	Clair	5000
T6512100	12	0.100	C-2V	Clair	5000
T6512120	12	0.120	C-2V	Clair	5000
T6518025	18	0.025	C-2F	Clair	5000
T6518055	18	0.055	C-2F	Clair	5000
T6524020	24	0.020	C-2F	Clair	5000
T6524025	24	0.025	C-2F	Clair	5000
T6524040	24	0.040	C-2F	Clair	5000
T6524050	24	0.050	C-2F	Clair	5000
T6524080	24	0.080	C-2F	Clair	5000
T6524100	24	0.100	C-2F	Clair	5000
T6526040	26	0.040	C-2F	Clair	5000
T6530020	30	0.020	C-2F	Clair	5000
T6530040	30	0.040	C-2F	Clair	5000
T6536020	36	0.020	C-2F	Clair	5000
T6536040	36	0.040	C-2F	Clair	5000
T6536050	36	0.050	C-2F	Clair	5000
T6536060	36	0.060	C-2F	Clair	5000
T6548020	48	0.020	CC-2F	Clair	5000
T6548025	48	0.025	CC-2F	Clair	5000
T6548030	48	0.030	CC-2F	Clair	5000
T6548040	48	0.040	CC-2F	Clair	5000
T6548050	48	0.050	CC-2F	Clair	5000

# Lampes Téléphoniques

## T6.5F Culot français

### 6X44mm

Numéro d'article	Voltage	Courant (A)	Filament	Teinte	Durée de vie (h)
T6548060	48	0.060	CC-2F	Clair	5000
T6552020	52	0.020	CC-2F	Clair	5000
T6560020	60	0.020	CC-2F	Clair	5000
T6560040	60	0.040	CC-2F	Clair	5000
T6560050	60	0.050	CC-2F	Clair	5000
T6560060	60	0.060	CC-2F	Clair	5000
T6570020	70	0.020	CC-2F	Clair	5000
T6585024	85	0.024	CC-2F	Clair	5000

# Lampes Téléphoniques

## T6.8G Culot allemand

### 7X44mm



Numéro d'article	Voltage	Courant (A)	Filament	Teinte	Durée de vie (h)
T6806020	6	0.020	C-2V	Clair	10000
T6806040	6	0.040	C-2V	Clair	5000
T6806050	6	0.050	C-2V	Clair	10000
T6806080	6	0.080	C-2V	Clair	5000
T6806100	6	0.100	C-2V	Clair	10000
T6806200	6	0.200	C-2R	Clair	5000
T6812020	12	0.020	C-2V	Clair	10000
T6812030	12	0.030	C-2V	Clair	5000
T6812040	12	0.040	C-2V	Clair	5000
T6812050	12	0.050	C-2V	Clair	10000
T6812080	12	0.080	C-2V	Clair	5000
T6812100	12	0.100	C-2V	Clair	10000
T6812120	12	0.120	C-2V	Clair	5000
T6818025	18	0.025	C-2F	Clair	5000
T6818040	18	0.040	C-2F	Clair	5000
T6818100	18	0.100	C-2F	Clair	5000
T6824020	24	0.020	C-2F	Clair	10000
T6824025	24	0.025	C-2F	Clair	5000
T6824035	24	0.035	C-2F	Clair	5000
T6824040	24	0.040	C-2F	Clair	10000
T6824050	24	0.050	C-2F	Clair	10000
T6824060	24	0.060	C-2F	Clair	5000
T6824080	24	0.080	C-2F	Clair	5000
T6824100	24	0.100	C-2F	Clair	5000
T6828025	28	0.025	C-2F	Clair	5000
T6828040	28	0.040	C-2F	Clair	5000
T6828045	28	0.045	C-2F	Clair	5000
T6828050	28	0.050	C-2F	Clair	5000
T6830020	30	0.020	C-2F	Clair	5000
T6830025	30	0.025	C-2F	Clair	5000

## Lampes Téléphoniques T6.8G Culot allemand 7X44mm

Numéro d'article	Voltage	Courant (A)	Filament	Teinte	Durée de vie (h)
T6830040	30	0.040	C-2F	Clair	10000
T6830050	30	0.050	C-2F	Clair	5000
T6830080	30	0.080	C-2F	Clair	5000
T6830100	30	0.100	C-2F	Clair	5000
T6836020	36	0.020	C-2F	Clair	10000
T6836033	36	0.033	C-2F	Clair	5000
T6836040	36	0.040	C-2F	Clair	10000
T6836050	36	0.050	C-2F	Clair	5000
T6836100	36	0.100	C-2F	Clair	5000
T6848020	48	0.020	CC-2F	Clair	10000
T6848025	48	0.025	CC-2F	Clair	5000
T6848040	48	0.040	CC-2F	Clair	5000
T6848050	48	0.050	CC-2F	Clair	5000
T6850020	50	0.020	CC-2F	Clair	5000
T6850050	50	0.050	CC-2F	Clair	5000
T6860020	60	0.020	CC-2F	Clair	5000
T6860040	60	0.040	CC-2F	Clair	5000
T6860050	60	0.050	CC-2F	Clair	5000
T6860060	60	0.060	CC-2F	Clair	5000
T6870020	70	0.020	CC-2F	Clair	5000
T6870025	70	0.025	CC-2F	Clair	5000
T6870030	70	0.030	CC-2F	Clair	5000
T6870040	70	0.040	CC-2F	Clair	5000
T6880020	80	0.020	CC-2F	Clair	5000
T6880040	80	0.040	CC-2F	Clair	5000
T6890020	90	0.020	CC-2F	Clair	5000

# Lampes Téléphoniques

## T6.0 Culot suédois

5X42mm

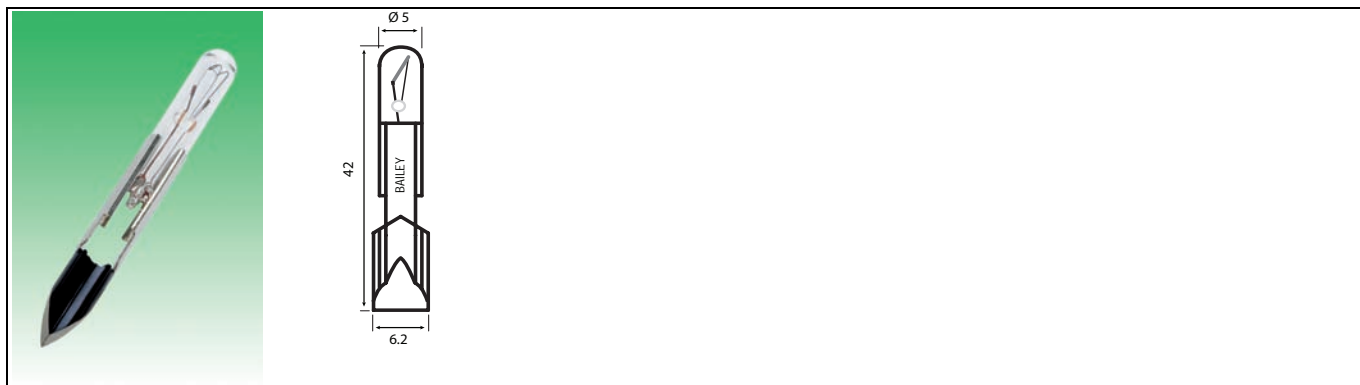

Numéro d'article	Voltage	Courant (A)	Filament	Teinte	Durée de vie (h)
T6006040	6	0.040	C-2V	Clair	5000
T6012020	12	0.020	C-2V	Clair	5000
T6012050	12	0.050	C-2V	Clair	5000
T6024020	24	0.020	C-2F	Clair	5000
T6024040	24	0.040	C-2F	Clair	5000
T6024050	24	0.050	C-2F	Clair	5000
T6024060	24	0.060	C-2F	Clair	5000
T6028045	28	0.045	C-2F	Clair	5000
T6028050	28	0.050	CC-2F	Clair	5000
T6036020	36	0.020	C-2F	Clair	5000
T6036035	36	0.035	C-2F	Clair	5000
T6036050	36	0.050	C-2F	Clair	5000
T6048020	48	0.020	CC-2F	Clair	5000
T6048030	48	0.030	CC-2F	Clair	5000
T6060020	60	0.020	CC-2F	Clair	5000
T6060040	60	0.040	CC-2F	Clair	5000
T6060055	60	0.055	CC-2F	Clair	5000
T6060060	60	0.060	CC-2F	Clair	5000

# Lampes Téléphoniques

## ESB

6.5X23mm

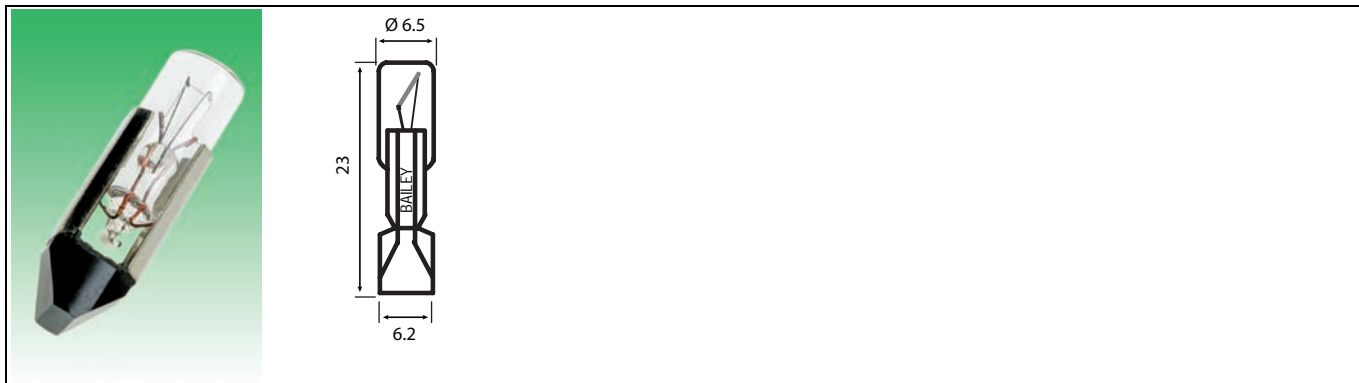

Numéro d'article	Voltage	Courant (A)	Filament	Teinte	Durée de vie (h)
T2304040	4	0.040	C-2R	Clair	10000
T2305040	5	0.040	C-2R	Clair	8000
T2306040	6	0.040	C-2V	Clair	10000
T2310040	10	0.040	C-2V	Clair	10000
T2312040	12	0.040	C-2V	Clair	10000
T2316040	16	0.040	C-2V	Clair	7500
T2318040	18	0.040	C-2V	Clair	5000
T2324040	24	0.040	C-2F	Clair	8000
T2328040	28	0.040	C-2F	Clair	6000
T2348040	48	0.040	CC-2F	Clair	5000

# Lampes Téléphoniques

## PSB

6.5X28mm

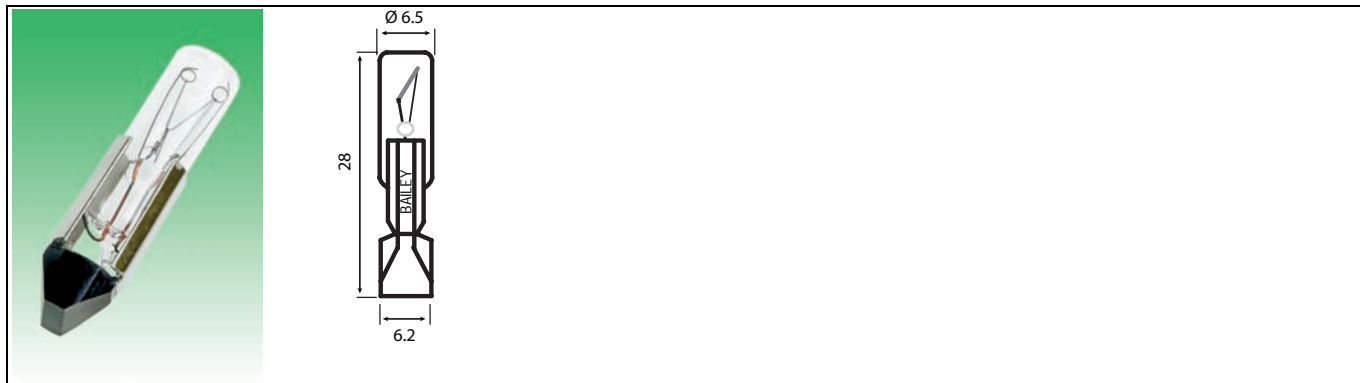

Numéro d'article	Voltage	Courant (A)	Filament	Teinte	Durée de vie (h)
T2806140	6	0.140	C-2F	Clair	20000
T2812170	12	0.170	C-2F	Clair	12000
T2824073	24	0.073	C-2F	Clair	10000
T2828040	28	0.040	C-2F	Clair	5000
T2848053	48	0.053	C-2F	Clair	5000
T2860050	60	0.050	CC-2F	Clair	7500
T2899025	120	0.025	CC-3A	Clair	10000
T2899026	155	0.025	CC-3A	Clair	10000

# Lampes Téléphoniques

## BPO Culot anglais

### 6X43mm

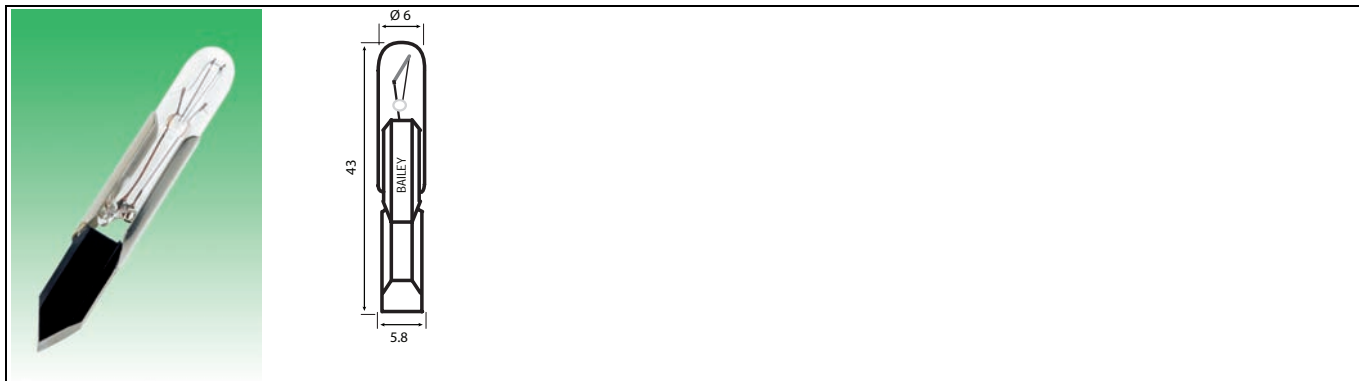

Numéro d'article	Voltage	Courant (A)	Filament	Teinte	Durée de vie (h)
T7006041	6	0.041	C-6	Clair	7000
T7012020	12	0.020	CC-6	Clair	5000
T7017045	17	0.045	C-2F	Clair	5000
T7024055	24	0.055	C-2F	Clair	1000
T7024100	24	0.100	C-2F	Clair	5000
T7045037	45	0.037	CC-2F	Clair	5000

# Lampes Téléphoniques

## F9

7X28mm

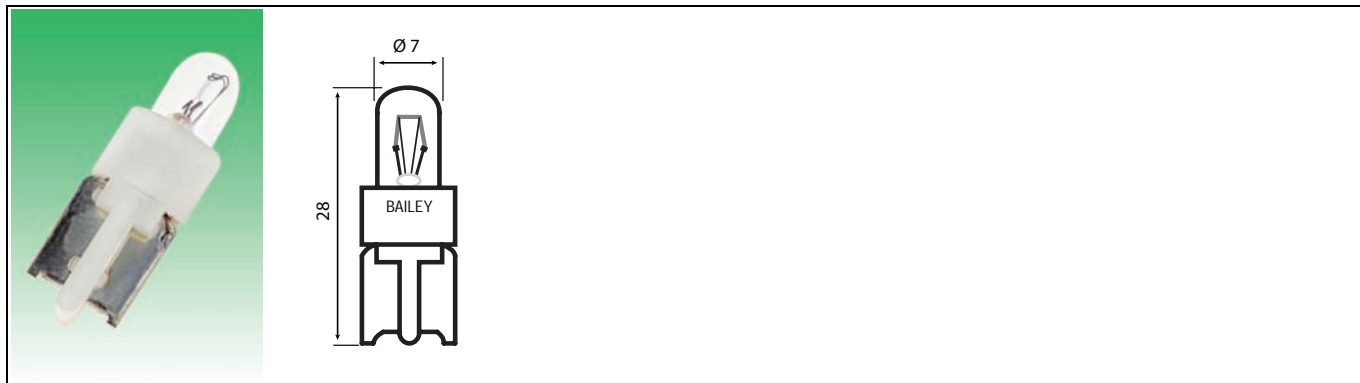

Numéro d'article	Voltage	Courant (A)	Filament	Teinte	Durée de vie (h)
F92804250	4	0.250	C-2R	Clair	3000
F92806180	6	0.180	C-2V	Clair	5000
F92812120	12	0.120	C-2V	Clair	5000
F92824040	24	0.040	C-2V	Clair	5000
F92824050	24	0.050	C-2F	Clair	5000
F92824080	24	0.080	C-2F	Clair	5000
F92828040	28	0.040	C-2F	Clair	5000
F92828050	28	0.050	C-2F	Clair	5000
F92830050	30	0.050	C-2F	Clair	5000
F92830070	30	0.070	C-2F	Clair	3000
F92836050	36	0.050	C-2F	Clair	5000
F92836070	36	0.070	C-2F	Clair	5000
F92848040	42	0.040	CC-2F	Clair	5000
F92848025	48	0.025	CC-2F	Clair	5000
F92848050	48	0.050	CC-2F	Clair	2500
F92860020	60	0.020	CC-2F	Clair	5000
F92870020	60	0.020	CC-2F	Clair	3000

# Lampes Téléphoniques

## T9

7X65mm

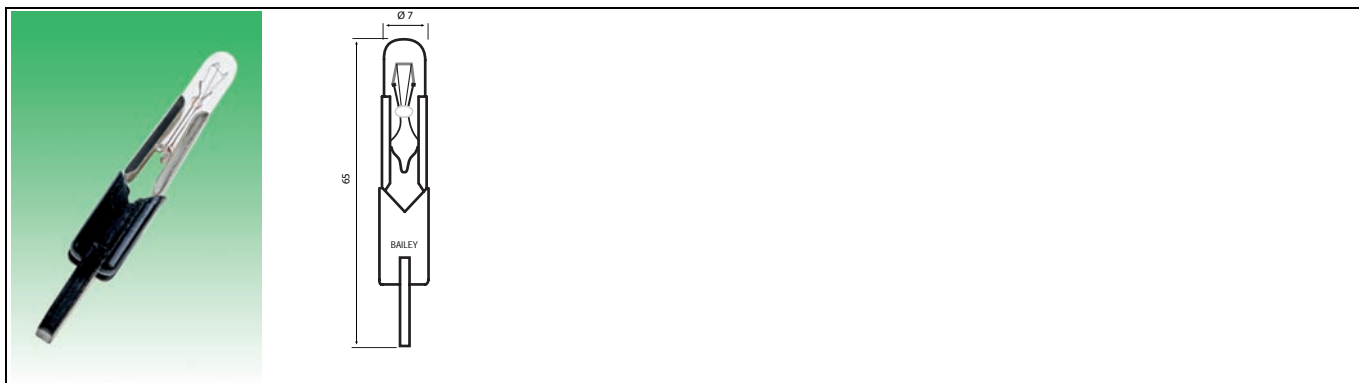

Numéro d'article	Voltage	Courant (A)	Filament	Teinte	Durée de vie (h)
T9024040	24	0.040	C-2F	Clair	2000
T9024080	24	0.080	C-2F	Clair	2000
T9024125	24	0.125	C-2F	Clair	10000
T9028105	28	0.105	C-2F	Clair	10000
T9040075	40	0.075	C-2F	Clair	2000
T9048045	48	0.045	CC-2F	Clair	5000
T9048065	48	0.065	C-2F	Clair	10000
T9060035	60	0.035	CC-2F	Clair	2000
T9060050	60	0.050	CC-2F	Clair	2000
T9070050	70	0.050	CC-2F	Clair	2000

# Lampes Ba7s

## Tube

### T7X20mm

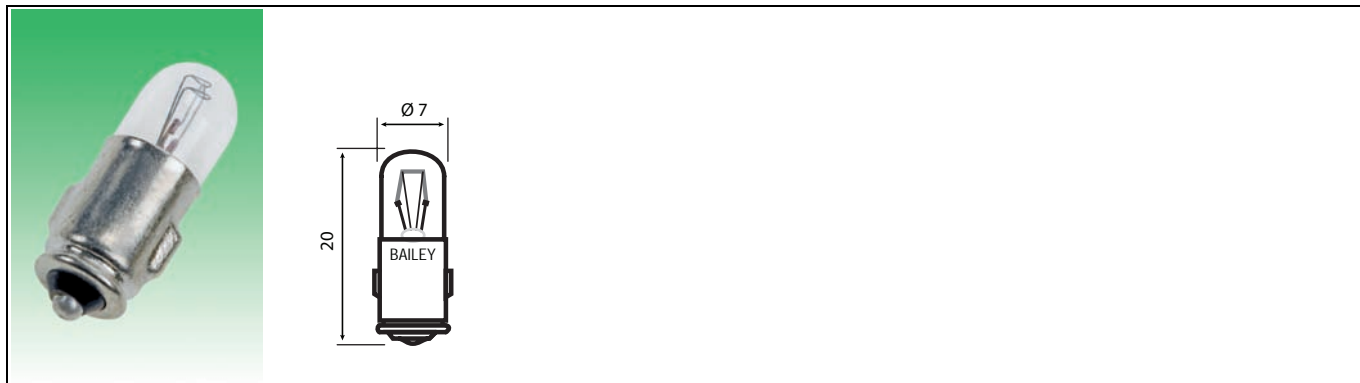

Numéro d'article	Voltage	Courant (A)	Wattage	Filament	Teinte	V (h)
B20002250	2.2	0.250	0.55	C-2R	Clair	2000
B20003667	3	0.667	2	C-2R	Clair	2000
B20006020	6	0.020	0.12	C-2V	Clair	2000
B20006040	6	0.040	0.24	C-2V	Clair	2000
B20006050	6	0.050	0.3	C-2V	Clair	2000
B20006080	6	0.080	0.48	C-2V	Clair	2000
B20006100	6	0.100	0.6	C-2R	Clair	2000
B20006180	6	0.180	1.1	C-2V	Clair	2000
B20006200	6	0.200	1.2	C-2R	Clair	2000
B20006200L	6	0.200	1.2	C-2V	Lentille	2000
B20006333	6	0.333	2	C-2R	Clair	2000
B20007100	7	0.100	0.7	C-2V	Clair	2000
B20012020	12	0.020	0.24	C-2V	Clair	2000
B20012025	12	0.025	0.3	C-2V	Clair	2000
B22012025	12	0.025	0.3	C-2F	Clair	2000
B20012050	12	0.050	0.6	C-2V	Clair	2000
B20012100	12	0.100	1.2	C-2V	Clair	2000
B20012120	12	0.120	1.44	C-2V	Clair	2000
B20012165	12	0.165	2	C-2V	Clair	2000
B20012250	12	0.250	3	C-2V	Clair	2000
B20014080	14	0.080	1.1	C-2V	Clair	2000
B20014100	14	0.100	1.4	C-2V	Clair	2000
B20024020	24	0.020	0.48	C-2F	Clair	2000
B20024025	24	0.025	0.6	C-2F	Clair	2000
B20024040	24	0.040	1	C-2F	Clair	2000
B20024050	24	0.050	1.2	C-2F	Clair	2000
B20024060	24	0.060	1.44	C-2F	Clair	2000
B20024080	24	0.080	2	C-2F	Clair	2000
B20024100	24	0.100	2.4	C-2F	Clair	2000
B20024125	24	0.125	3	C-2F	Clair	2000

# Lampes Ba7s

## Tube

### T7X20mm

Numéro d'article	Voltage	Courant (A)	Wattage	Filament	Teinte	V (h)
B20024170	24	0.170	4	C-2F	Clair	2000
B20028020	28	0.020	0.56	C-2F	Clair	2000
B20028025	28	0.025	0.7	C-2F	Clair	2000
B20028040	28	0.040	1.12	C-2F	Clair	2000
B20028040R	28	0.040	1.12	C-2F	Rouge	2000
B20028050	28	0.050	1.4	C-2F	Clair	2000
B20028060	28	0.060	1.7	C-2F	Clair	2000
B20028070	28	0.070	2	C-2F	Clair	2000
B20028100	28	0.100	2.8	C-2F	Clair	2000
B20030025	30	0.025	0.75	C-2F	Clair	2000
B20030030	30	0.030	0.9	C-2F	Clair	2000
B20030040	30	0.040	1.2	C-2F	Clair	2000
B20030050	30	0.050	1.5	C-2F	Clair	2000
B20030060	30	0.060	1.8	C-2F	Clair	2000
B20030065	30	0.065	2	C-2F	Clair	2000
B20030070	30	0.070	2.1	C-2F	Clair	2000
B20030100	30	0.100	3	C-2F	Clair	2000
B20036020	36	0.020	0.7	C-2F	Clair	2000
B20036040	36	0.040	1.44	C-2F	Clair	2000
B20036050	36	0.050	1.8	C-2F	Clair	2000
B20048020	48	0.020	1	C-2F	Clair	2000
B20048025	48	0.025	1.2	C-2F	Clair	2000
B20048030	48	0.030	1.44	C-2F	Clair	2000
B20048040	48	0.040	2	C-2F	Clair	2000
B20048050	48	0.050	2.4	C-2F	Clair	2000
B20060020	60	0.020	1.2	C-2F	Clair	2000
B20060025	60	0.025	1.5	C-2F	Clair	2000
B20060040	60	0.040	2.4	C-2F	Clair	2000
B20060050	60	0.050	3	C-2F	Clair	2000
B20070020	70	0.020	1.4	CC-2F	Clair	2000

# Lampes Ba7s Tube

T6.6X20mm Culot DIN



Numéro d'article	Voltage	Courant (A)	Wattage	Filament	Teinte	V (h)
B20006100S	6	0.100	0.6	C-2V	Clair	2000
B20012050S	12	0.050	0.6	C-2V	Clair	2000
B20012100S	12	0.100	1.2	C-2V	Clair	2000
B20024025S	24	0.025	0.6	C-2F	Clair	2000
B20024050S	24	0.050	1.2	C-2F	Clair	2000
B20024080S	24	0.080	2	C-2F	Clair	2000
B20030040S	30	0.040	1.2	C-2F	Clair	2000
B20030050S	30	0.050	1.5	C-2F	Clair	2000
B20030065S	30	0.065	2	C-2F	Clair	2000
B20036040S	36	0.040	1.44	C-2F	Clair	2000
B20036050S	36	0.050	1.8	C-2F	Clair	2000
B20060020S	60	0.020	1.2	C-2F	Clair	2000

# Lampes Ba7s

## Tube

### T7X23mm



Numéro d'article	Voltage	Courant (A)	Wattage	Filament	Teinte	V (h)
B22006020	6	0.020	0.12	C-2V	Clair	2000
B22006040	6	0.040	0.24	C-2V	Clair	2000
B22006050	6	0.050	0.3	C-2V	Clair	2000
B22006080	6	0.080	0.48	C-2V	Clair	2000
B22006100	6	0.100	0.6	C-2V	Clair	2000
B22006180	6	0.180	1.1	C-2V	Clair	2000
B22006200	6	0.200	1.2	C-2R	Clair	2000
B22007100	7	0.100	0.7	C-2V	Clair	2000
B22012050	12	0.050	0.6	C-2V	Clair	2000
B22012100	12	0.100	1.2	C-2V	Clair	2000
B22012120	12	0.120	1.44	C-2V	Clair	2000
B22012170	12	0.170	2	C-2V	Clair	2000
B22014080	14	0.080	1.1	C-2V	Clair	2000
B22014100	14	0.100	1.4	C-2V	Clair	2000
B22016100	16	0.100	1.6	C-2V	Clair	2000
B22018100	18	0.100	1.8	C-2V	Clair	2000
B22018150	18	0.150	2.7	C-2F	Clair	2000
B22024020	24	0.020	0.48	C-2F	Clair	2000
B22024025	24	0.025	0.6	C-2F	Clair	2000
B22024040	24	0.040	1	C-2F	Clair	2000
B22024050	24	0.050	1.2	C-2F	Clair	2000
B22024060	24	0.060	1.5	C-2F	Clair	2000
B22024070	24	0.070	1.7	C-2F	Clair	2000
B22024080	24	0.080	2	C-2F	Clair	2000
B22024100	24	0.100	2.4	C-2F	Clair	2000
B22024125	24	0.125	3	C-2F	Clair	2000
B22028020	28	0.020	0.56	C-2F	Clair	2000
B22028025	28	0.025	0.7	C-2F	Clair	2000
B22028040	28	0.040	1.1	C-2F	Clair	2000
B22028060	28	0.060	1.7	C-2F	Clair	2000

# Lampes Ba7s

## Tube

### T7X23mm

Numéro d'article	Voltage	Courant (A)	Wattage	Filament	Teinte	V (h)
B22028070	28	0.070	2	C-2F	Clair	2000
B22030020	30	0.020	0.6	C-2F	Clair	2000
B22030025	30	0.025	0.75	C-2F	Clair	2000
B22030030	30	0.030	0.9	C-2F	Clair	2000
B22030040	30	0.040	1.2	C-2F	Clair	2000
B22030050	30	0.050	1.5	C-2F	Clair	2000
B22030065	30	0.065	2	C-2F	Clair	2000
B22030070	30	0.070	2.1	C-2F	Clair	2000
B22030100	30	0.100	3	C-2F	Clair	2000
B22036020	36	0.020	0.7	C-2F	Clair	2000
B22036025	36	0.025	0.9	C-2F	Clair	2000
B22036030	36	0.030	1.1	C-2F	Clair	2000
B22036035	36	0.035	1.3	C-2F	Clair	2000
B22036040	36	0.040	1.44	C-2F	Clair	2000
B22036050	36	0.050	1.8	C-2F	Clair	2000
B22048020	48	0.020	1	C-2F	Clair	2000
B22048025	48	0.025	1.2	C-2F	Clair	2000
B22048030	48	0.030	1.44	C-2F	Clair	2000
B22048040	48	0.040	2	C-2F	Clair	2000
B22048050	48	0.050	2.4	C-2F	Clair	2000
B22052025	52	0.025	1.3	C-2F	Clair	2000
B22060020	60	0.020	1.2	C-2F	Clair	2000
B22060025	60	0.025	1.5	C-2F	Clair	2000
B22060040	60	0.040	2.4	C-2F	Clair	2000
B22060050	60	0.050	3	C-2F	Clair	2000
B22070020	70	0.020	1.4	C-2F	Clair	2000
B22070040	70	0.040	2.8	C-2F	Clair	2000
B22080020	80	0.020	1.6	CC-2F	Clair	2000

## Lampes Ba7s

### Tube

T6.6X23mm Culot DIN



Numéro d'article	Voltage	Courant (A)	Wattage	Filament	Teinte	V (h)
B22024025S	24	0.025	0.6	C-2F	Clair	2000
B22024050S	24	0.050	1.2	C-2F	Clair	2000
B22024080S	24	0.080	2	C-2F	Clair	2000
B22030050S	30	0.050	1.5	C-2F	Clair	2000
B22048020S	48	0.020	1	C-2F	Clair	2000
B22060020S	60	0.020	1.2	C-2F	Clair	2000

# Lampes Ba9s

## Tube

### T9X23mm

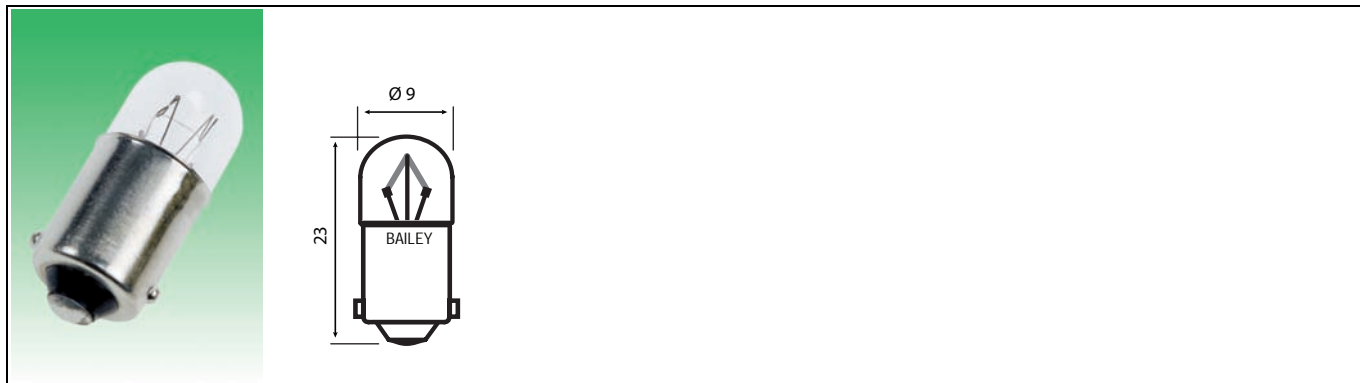

Numéro d'article	Voltage	Courant (A)	Wattage	Filament	Teinte	Durée de vie (h)	Code US
B23002200	2	0.200	0.4	C-2R	Clair	2000	
B23002600	2.4	0.600	1.44	C-2R	Clair	2000	
B23002500	2.5	0.500	1.25	C-2R	Clair	2000	
B23004250	4	0.250	1	C-2R	Clair	2000	
B23004313	4.8	0.313	1.5	C-2R	Clair	2000	
B23006020	6	0.020	0.12	C-2R	Clair	2000	
B23006030	6	0.030	0.18	C-2R	Clair	2000	
B23006040	6	0.040	0.24	C-2R	Clair	2000	
B23006050	6	0.050	0.3	C-2V	Clair	2000	
B23006080	6	0.080	0.48	C-2V	Clair	2000	
B23006100	6	0.100	0.6	C-2V	Clair	2000	
B23006180	6	0.180	1.08	C-2V	Clair	2000	
B23006200	6	0.200	1.2	C-2V	Clair	2000	
B23008250	6-8	0.250	1.75	C-2R	Clair	2000	
B23006333	6	0.333	2	C-2R	Clair	2000	
B23006350	6	0.350	2.1	C-2R	Clair	2000	
B23006500	6	0.500	3	C-2R	Clair	2000	
B23006666	6	0.666	4	C-2R	Clair	2000	
B23006999	6	1.000	6	C-2R	Clair	2000	
B23006150	6.3	0.150	0.95	C-2V	Clair	2000	
B23006160	6.3	0.160	1	C-2V	Clair	2000	
B23006190	6.3	0.190	1.2	C-2R	Clair	2000	
B23006250	6.3	0.250	1.6	C-2R	Clair	2000	
B23006300	6.3	0.300	1.89	C-2R	Clair	2000	
B23015001	12-15		1.2	C-2F	Clair	2000	
B23015002	12-15		2	C-2V	Clair	2000	
B23012020	12	0.020	0.24	C-2V	Clair	2000	
B23012030	12	0.030	0.36	C-2V	Clair	2000	
B23012050	12	0.050	0.6	C-2V	Clair	2000	

# Lampes Ba9s

## Tube

### T9X23mm

Numéro d'article	Voltage	Courant (A)	Wattage	Filament	Teinte	Durée de vie (h)	Code US
B23012100	12	0.100	1.2	C-2V	Clair	2000	
B23012120	12	0.120	1.44	C-2V	Clair	2000	
B23012165	12	0.165	2	C-2V	Clair	2000	
B23012180	12	0.180	2.2	C-2V	Clair	2000	
B23012250	12	0.250	3	C-2V	Clair	2000	
B23012333	12	0.333	4	C-2F	Clair	2000	
B23012417	12	0.417	5	C-2V	Clair	2000	
B23015140	15	0.140	2.1	C-2F	Clair	2000	
B23018100	18	0.100	1.8	C-2V	Clair	2000	
B23030002	24-30		2	C-2F	Clair	2000	
B23024025	24	0.025	0.6	C-2F	Clair	2000	
B23024050	24	0.050	1.2	C-2F	Clair	2000	
B230240505RC	24	0.050	1.2	CC-2F	Clair	20000	
B23024060	24	0.060	1.44	C-2F	Clair	2000	
B23024080	24	0.080	2	C-2F	Clair	2000	
B23024100	24	0.100	2.4	C-2F	Clair	2000	
B23024125	24	0.125	3	C-2F	Clair	2000	
B23024165	24	0.165	4	C-2F	Clair	2000	
B23026038	26	0.038	1	C-2F	Clair	2000	
B23026115	26	0.115	3	C-2F	Clair	2000	
B23028040	28	0.040	1.1	C-2F	Clair	2000	
B23028060	28	0.060	1.7	C-2F	Clair	2000	
B23028070	28	0.070	2	C-2F	Clair	2000	
B23028080	28	0.080	2.2	C-2F	Clair	2000	
B23030020	30	0.020	0.6	C-2F	Clair	2000	
B23030033	30	0.033	1	C-2F	Clair	2000	
B23030040	30	0.040	1.2	C-2F	Clair	2000	
B23030050	30	0.050	1.5	C-2F	Clair	2000	
B23030065	30	0.065	2	C-2F	Clair	2000	
B23030070	30	0.070	2.1	C-2F	Clair	2000	
B23030080	30	0.080	2.4	C-2F	Clair	2000	
B23030100	30	0.100	3	C-2F	Clair	2000	
B23032100	32	0.100	3.2	C-2F	Clair	2000	
B23045002	36-45		2	C-2F	Clair	2000	
B23045003	36-45		3	C-2F	Clair	2000	
B23036020	36	0.020	0.72	C-2F	Clair	2000	
B23036030	36	0.030	1.1	C-2F	Clair	2000	
B23036040	36	0.040	1.44	C-2F	Clair	2000	
B23036050	36	0.050	1.8	C-2F	Clair	2000	

# Lampes Ba9s

## Tube

### T9X23mm

Numéro d'article	Voltage	Courant (A)	Wattage	Filament	Teinte	Durée de vie (h)	Code US
B23036055	36	0.055	2	C-2F	Clair	2000	
B23036080	36	0.080	2.88	C-2F	Clair	2000	
B23036085	36	0.085	3	C-2F	Clair	2000	
B23040075	40	0.075	3	C-2F	Clair	2000	
B23042045	42	0.045	1.89	C-2F	Clair	2000	
B23042050	42	0.050	2.1	C-2F	Clair	2000	
B23042070	42	0.070	3	C-2F	Clair	2000	
B23060002	48-60		2	C-2F	Clair	2000	
B23060003	48-60		3	C-2F	Clair	2000	
B23048020	48	0.020	1	C-2F	Clair	2000	
B23048025	48	0.025	1.2	C-2F	Clair	2000	
B23048040	48	0.040	2	C-2F	Clair	2000	
B23048050	48	0.050	2.4	C-2F	Clair	2000	
B23048060	48	0.060	3	C-2F	Clair	2000	
B23070002	60-70		2	C-2F	Clair	2000	
B23060020	60	0.020	1.2	C-2F	Clair	2000	
B23060033	60	0.033	2	C-2F	Clair	2000	
B23060040	60	0.040	2.4	C-2F	Clair	2000	
B23060050	60	0.050	3	C-2F	Clair	2000	
B23070030	70	0.030	2.1	C-2F	Clair	2000	
B23070040	70	0.040	2.8	C-2F	Clair	2000	
B23080040	70-80	0.040		C-3A	Clair	2000	
B23080020	80	0.020	1.6	C-3A	Clair	2000	
B23080030	80	0.030	2.4	C-3A	Clair	2000	
B23085030	85	0.030	2.6	C-3A	Clair	2000	
B23100040	100	0.040	4	C-3A	Clair	2000	
B23110022	110	0.022	2.45	CC-5A	Clair	2000	
B23130015	130	0.015	2	C-5A	Clair	2000	
B23130016	130	0.015	2	CC-3A	Clair	2000	
B23130020	130	0.020	2.6	C-5A	Clair	2000	
B23130021	130	0.020	2.6	CC-6A	Clair	5000	
B23220009	220	0.009	2	CC-7A	Clair	2000	
B23220014	220	0.014	3	CC-7A	Clair	2000	
B23240010	240	0.010	2.4	CC-7A	Clair	2000	
B23240013	240	0.013	3	CC-7A	Clair	2000	

## Lampes Ba9s

### Tube

T8.5X23mm Culot DIN



Numéro d'article	Voltage	Courant (A)	Wattage	Filament	Teinte	Durée de vie (h)	Code US
BR23006333	6	0.333	2	C-2F	Clair	2000	
BR23012165	12	0.165	2	C-2V	Clair	2000	
BR23024080	24	0.080	2	C-2F	Clair	2000	
BR230240802	24	0.080	2	C-2F	Clair	5000	
BR230280802	28	0.080	2.24	C-2F	Clair	5000	
BR23030040	30	0.040	1.2	C-2F	Clair	2000	
BR23030065	30	0.065	2	C-2F	Clair	2000	
BR23030070	30	0.070	2.1	C-2F	Clair	2000	
BR23036055	36	0.055	2	C-2F	Clair	2000	
BR23048040	48	0.040	2	C-2F	Clair	2000	
BR23060020	60	0.020	1.2	C-2F	Clair	2000	

# Lampes Ba9s Tube T10X28mm

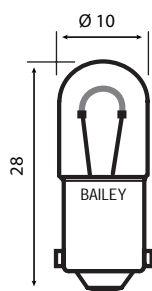

Numéro d'article	Voltage	Courant (A)	Wattage	Filament	Teinte	Durée de vie (h)	Code US
B28001050	1.5	0.050	0.08	C-2R	Clair	2000	
B28001150	1.5	0.150	0.23	C-2R	Clair	2000	
B28002060	2	0.060	0.06	C-2V	Clair	2000	49
B28002600	2	0.600	1.2	C-2R	Clair	2000	
B28002150	2.4	0.150	0.36	C-2R	Clair	2000	
B28002200	2.5	0.200	0.5	C-2R	Clair	2000	
B28002300	2.5	0.300	0.75	C-2R	Clair	2000	
B28002500	2.5	0.500	1.25	C-2R	Clair	2000	43
B28002998	2.5	1.000	2.5	C-2R	Clair	2000	
B28003650	3	0.650	1.95	C-2R	Clair	2000	
B28003200	3.5	0.200	0.7	C-2R	Clair	2000	
B28003150	3.6	0.150	0.54	C-2R	Clair	2000	
B28003250	3.6	0.250	0.9	C-2R	Clair	2000	
B28003201	3.8	0.200	0.76	C-2R	Clair	2000	
B28004040	4	0.040	0.16	C-2R	Clair	2000	
B28004100	4	0.100	0.4	C-2R	Clair	2000	
B28004250	4	0.250	1	C-2R	Clair	2000	
B28004300	4	0.300	1.2	C-2R	Clair	2000	
B28004500	4	0.500	2	C-2R	Clair	2000	
B28005050	5	0.050	0.25	C-2R	Clair	2000	
B28005070	5	0.070	0.35	C-2V	Clair	2000	
B28005090	5	0.090	0.45	C-2R	Clair	2000	1850
B28005150	5	0.150	0.75	C-2R	Clair	2000	
B28005300	5	0.300	1.5	C-2R	Clair	2000	
B28005900	5	0.900	4.5	C-2R	Clair	2000	
B28006020	6	0.020	0.12	C-2V	Clair	2000	
B28006030	6	0.030	0.18	C-2V	Clair	2000	
B28006050	6	0.050	0.3	C-2R	Clair	2000	
B28006075	6	0.075	0.45	C-2V	Clair	2000	

# Lampes Ba9s

## Tube

### T10X28mm

Numéro d'article	Voltage	Courant (A)	Wattage	Filament	Teinte	Durée de vie (h)	Code US
B28006090	6	0.090	0.54	C-2V	Clair	2000	
B28006100	6	0.100	0.6	C-2V	Clair	2000	
B28006180	6	0.180	1.1	C-2R	Clair	2000	
B28006200	6	0.200	1.2	C-2R	Clair	2000	
B28006251	6	0.250	1.5	C-2R	Clair	2000	
B28008250	6-8	0.250		C-2R	Clair	2000	
B28006300	6	0.300	1.8	C-2R	Clair	2000	
B28006333	6	0.333	2	C-2R	Clair	2000	
B28006350	6	0.350	2.1	C-2R	Clair	2000	
B28006500	6	0.500	3	C-2R	Clair	2000	
B28006700	6	0.700	4.2	C-2R	Clair	2000	
B28006830	6	0.830	5	C-2R	Clair	2000	
B28006999	6	1.000	6	C-2R	Clair	2000	
B28006150	6.3	0.150	0.95	C-2V	Clair	2000	47
B28006250	6.3	0.250	1.6	C-2R	Clair	2000	44
B28006300BL	6.3	0.300	1.89	Blinker	Clair	2000	
B28006302	6.3	0.300	1.89	C-2R	Clair	2000	
B28006320	6.3	0.320	2.02	C-2R	Clair	2000	
B28006151	6.5	0.150	0.98	C-2V	Clair	2000	
B28006301	6.5	0.300	1.95	C-2R	Clair	2000	
B28007100	7	0.100	0.7	C-2V	Clair	2000	
B28007300	7	0.300	2.1	C-2R	Clair	2000	
B28007570	7	0.570	4	C-2R	Clair	2000	
B28008100	8	0.100	0.8	C-2V	Clair	2000	
B28008300	8	0.300	2.4	C-2V	Clair	2000	
B28010050	10	0.050	0.5	C-2V	Clair	2000	
B28010135	10	0.135	1.35	C-2V	Clair	2000	
B28010200	10	0.200	2	C-2V	Clair	2000	
B28015002	12-15		2	C-2V	Clair	2000	
B28015004	12-15		4	C-2V	Clair	2000	
B28012030	12	0.030	0.36	C-2V	Clair	2000	
B28012050	12	0.050	0.6	C-2V	Clair	2000	
B28012080	12	0.080	1	C-2V	Clair	2000	
B28012100	12	0.100	1.2	C-2V	Clair	2000	
B28012120	12	0.120	1.44	C-2V	Clair	2000	
B28012150	12	0.150	1.8	C-2V	Clair	2000	
B28012165	12	0.165	2	C-2V	Clair	2000	
B28012183	12	0.183	2.2	C-2V	Clair	2000	
B28012200	12	0.200	2.4	C-2V	Clair	2000	

# Lampes Ba9s Tube T10X28mm

Numéro d'article	Voltage	Courant (A)	Wattage	Filament	Teinte	Durée de vie (h)	Code US
B28012250	12	0.250	3	C-2V	Clair	2000	
B280122502	12	0.250	3	C-2V	Clair	5000	
B28012330	12	0.330	4	C-2V	Clair	2000	
B28012417	12	0.417	5	C-2V	Clair	2000	
B28014080	14	0.080	1.1	C-2V	Clair	2000	
B28014100	14	0.100	1.4	C-2V	Clair	2000	1813
B28014200	14	0.200	2.8	C-2R	Clair	2000	1815
B28014240	14	0.240	3.4	C-2R	Clair	2000	1891
B28015050	15	0.050	0.75	C-2F	Clair	2000	
B28015100	15	0.100	1.5	C-2F	Clair	2000	
B28015200	15	0.200	3	C-2F	Clair	2000	
B28016150	16	0.150	2.4	C-2V	Clair	2000	
B28018050	18	0.050	0.9	C-2V	Clair	2000	
B28018100	18	0.100	1.8	C-2V	Clair	2000	
B28018170	18	0.170	3	C-2V	Clair	2000	1826
B28030002	24-30		2	C-2F	Clair	2000	
B28030004	24-30		4	C-2F	Clair	2000	
B28024025	24	0.025	0.6	C-2F	Clair	2000	
B28024040	24	0.040	1	C-2F	Clair	2000	
B28024050	24	0.050	1.2	C-2F	Clair	2000	
B28024060	24	0.060	1.44	C-2F	Clair	2000	
B28024080	24	0.080	2	C-2F	Clair	2000	
B280240802	24	0.080	2	C-2F	Clair	5000	
B28024100	24	0.100	2.4	C-2F	Clair	2000	
B28024125	24	0.125	3	C-2F	Clair	2000	
B28024165	24	0.165	4	C-2F	Clair	2000	
B28024208	24	0.208	5	C-2F	Clair	2000	
B28027075	27	0.075	2	C-2F	Clair	2000	
B28028022	28	0.022	0.62	C-2F	Clair	2000	
B28028025	28	0.025	0.7	C-2F	Clair	2000	
B28028040	28	0.040	1.1	C-2F	Clair	5000	
B28028050	28	0.050	1.4	C-2F	Clair	2000	
B28028060	28	0.060	1.7	C-2F	Clair	2000	
B28028070	28	0.070	2	C-2F	Clair	2000	1829
B28028080	28	0.080	2.2	C-2F	Clair	2000	
B28028100	28	0.100	2.8	C-2F	Clair	2000	1820
B28028107	28	0.107	3	C-2F	Clair	2000	
B28028125	28	0.125	3.5	C-2F	Clair	500	
B28028170	28	0.170	5	C-2F	Clair	2000	1864

# Lampes Ba9s

## Tube

### T10X28mm

Numéro d'article	Voltage	Courant (A)	Wattage	Filament	Teinte	Durée de vie (h)	Code US
B28028200	28	0.200	5.6	C-2F	Clair	2000	1873
B28032002	30-32		2	C-2F	Clair	2000	
B28030020	30	0.020	0.6	C-2F	Clair	2000	
B28030025	30	0.025	0.75	C-2F	Clair	2000	
B28030030	30	0.030	0.9	C-2F	Clair	2000	
B28030033	30	0.033	1	C-2F	Clair	2000	
B28030040	30	0.040	1.2	C-2F	Clair	2000	
B28030050	30	0.050	1.5	C-2F	Clair	2000	
B28030065	30	0.065	2	C-2F	Clair	2000	
B28030080	30	0.080	2.4	C-2F	Clair	2000	
B28030100	30	0.100	3	C-2F	Clair	2000	
B28030167	30	0.167	5	C-2F	Clair	2000	
B28032170	32	0.170	5.4	C-2F	Clair	2000	
B28045002	36-45		2	C-2F	Clair	2000	
B28045004	36-45		4	C-2F	Clair	2000	
B28036020	36	0.020	0.72	C-2F	Clair	2000	
B28036030	36	0.030	1.1	C-2F	Clair	2000	
B28036040	36	0.040	1.44	C-2F	Clair	2000	
B28036050	36	0.050	1.8	C-2F	Clair	2000	
B28036055	36	0.055	2	C-2F	Clair	2000	
B28036085	36	0.085	3	C-2F	Clair	2000	
B28036100	36	0.100	3.6	C-2F	Clair	2000	
B28036110	36	0.110	4	C-2F	Clair	2000	
B28042025	42	0.025	1	C-2F	Clair	2000	
B28042028	42	0.028	1.2	C-2F	Clair	2000	
B28042045	42	0.045	1.9	C-2F	Clair	2000	
B28042050	42	0.050	2.1	C-2F	Clair	2000	
B28042070	42	0.070	3	C-2F	Clair	2000	
B28060002	48-60		2	C-2F	Clair	2000	
B28060004	48-60		4	C-2F	Clair	2000	
B28048020	48	0.020	1	C-2F	Clair	2000	
B28048025	48	0.025	1.2	C-2F	Clair	2000	
B28048040	48	0.040	2	C-2F	Clair	2000	
B28048050	48	0.050	2.4	C-2F	Clair	2000	
B28048060	48	0.060	3	C-2F	Clair	2000	
B28048080	48	0.080	4	C-2F	Clair	2000	
B28048105	48	0.105	5	C-2F	Clair	2000	
B28050050	50	0.050	2.5	C-2F	Clair	2000	
B28050080	50	0.080	4	C-2F	Clair	2000	

# Lampes Ba9s Tube T10X28mm

Numéro d'article	Voltage	Courant (A)	Wattage	Filament	Teinte	Durée de vie (h)	Code US
B28050100	50	0.100	5	C-2F	Clair	2000	
B28052060	52	0.060	3	C-2F	Clair	2000	
B28055050	55	0.050	2.75	C-2F	Clair	2000	1835
B28060020	60	0.020	1.2	C-2F	Clair	2000	
B28060030	60	0.030	1.8	C-2F	Clair	2000	
B28060033	60	0.033	2	C-2F	Clair	2000	
B28060040	60	0.040	2.4	C-2F	Clair	2000	
B28060050	60	0.050	3	C-2F	Clair	2000	
B28060060	60	0.060	3.6	C-2F	Clair	2000	
B28060085	60	0.085	5	C-2F	Clair	2000	
B28065085	65	0.085	5.5	C-2F	Clair	2000	
B28070020	70	0.020	1.4	C-2F	Clair	2000	
B28070040	70	0.040	2.8	C-2F	Clair	2000	
B28080003	70-80	0.040		C-2F	Clair	2000	
B28080025	80	0.025	2	C-3A	Clair	2000	
B28080040	80	0.040	3.2	C-2F	Clair	2000	
B28085024	85	0.024	2	C-3A	Clair	2000	
B28085035	85	0.035	3	C-3A	Clair	2000	
B28085050	85	0.050	4.25	C-3A	Clair	2000	
B28110022	110	0.022	2.5	C-5A	Clair	2000	
B28130015	130	0.015	2	C-5A	Clair	2000	
B28130016	130	0.015	2	CC-3A	Clair	2000	
B28130018	130	0.018	2.4	C-5A	Clair	2000	
B28130020	130	0.020	2.6	C-5A	Clair	1000	
B28130021	130	0.020	2.6	CC-6A	Clair	5000	
B28130022	130	0.020	2.6	2XCC-2F	Clair	25000	
B28130030	130	0.030	3.9	C-5A	Clair	2000	
B28130038	130	0.038	5	C-5A	Clair	20000	
B28150020	150	0.020	3	C-5A	Clair	2000	
B28160020	160	0.020	3.2	C-5A	Clair	2000	
B28220009	220	0.009	2	CC-7A	Clair	2000	
B28220014	220	0.014	3	C-7A	Clair	2000	
B282200142	220	0.014	3	CC-7A	Clair	5000	
B28220018	220	0.018	4	C-7A	Clair	2000	
B28220023	220	0.023	5	C-7A	Clair	2000	
B28230013	230	0.013	3	C-7A	Clair	2000	
B28240010	240	0.010	2.4	CC-7A	Clair	2000	
B28240013	240	0.013	3	CC-7A	Clair	2000	
B28240017	240	0.017	4	CC-7A	Clair	2000	

## Lampes Ba9s

### Tube

T8.5X28mm Culot DIN



Numéro d'article	Voltage	Courant (A)	Wattage	Filament	Teinte	Durée de vie (h)	Code US
BR28006333	6	0.333	2	C-2V	Clair	2000	
BR28012165	12	0.165	2	C-2F	Clair	2000	
BR28024050	24	0.050	1.2	C-2F	Clair	2000	
BR28024080	24	0.080	2	C-2F	Clair	2000	
BR280240802	24	0.080	2	C-2F	Clair	5000	
BR28028040	28	0.040	1.1	C-2F	Clair	2000	
BR28030065	30	0.065	2	C-2F	Clair	2000	
BR28036055	36	0.055	2	C-2F	Clair	2000	

**Lampes Ba9s  
Tube  
T10X39mm**



Numéro d'article	Voltage	Courant (A)	Wattage	Filament	Teinte	Durée de vie (h)	Code US
B39024125	24	0.125	3	C-2F	Clair	2000	
B39030100	30	0.100	3	C-2F	Clair	2000	
B39048063	48	0.063	3	C-2F	Clair	2000	
B39053130	53	0.130	7	C-2F	Clair	3000	
B39060050	60	0.050	3	C-2F	Clair	2000	
B39090003	80-90		3	CC-3A	Clair	2000	
B39130020	130	0.020	2.6	CC-3A	Clair	2000	
B39160022	160	0.022	4	C-5A	Clair	2000	
B39220014	220	0.014	3	C-7A	Clair	1000	
B39230017	230	0.017	3	CC-6A	Clair	1000	

**Lampes Ba9s**  
**Tube Telewriter**  
**T6.8X35mm**

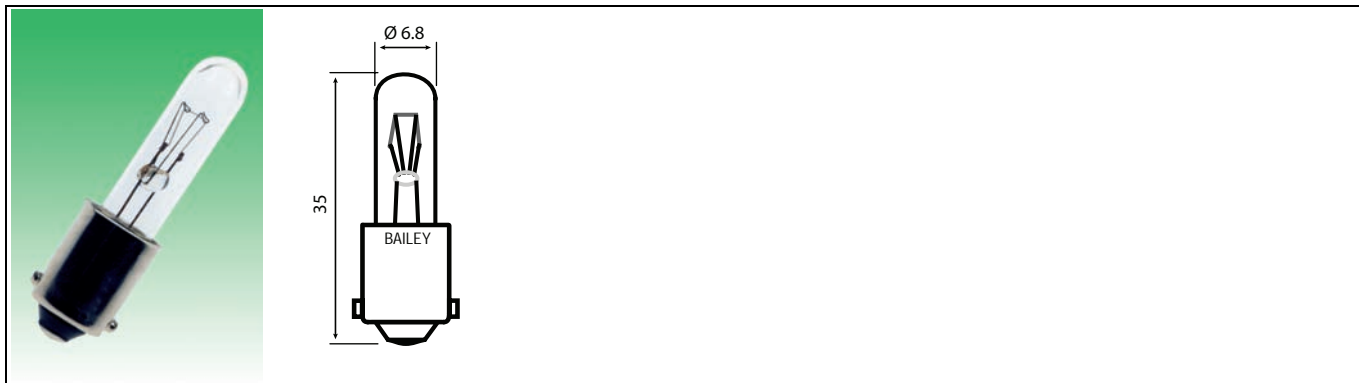

Numéro d'article	Voltage	Courant (A)	Wattage	Filament	Teinte	Durée de vie (h)	Code US
BT35024100	24	0.100	2.4	CC-2F	Clair	1000	
BT35050055	50	0.055	2.75	CC-2F	Clair	1000	

# Lampes Ba9s

## Sphérique

### G11X24mm

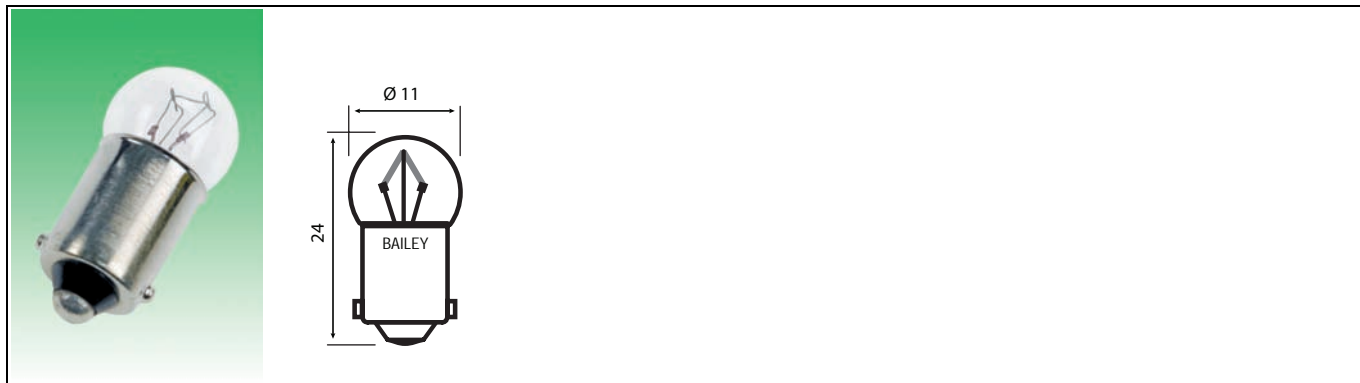

Numéro d'article	Voltage	Courant (A)	Wattage	Filament	Teinte	Durée de vie (h)	Code US
B24002301	2	0.300	0.6	C-2R	Clair	2000	
B24002999	2.4	1.250	3	C-2R	Clair	2000	
B24002200	2.5	0.200	0.5	C-2R	Clair	2000	
B24002300	2.5	0.300	0.75	C-2R	Clair	2000	
B24002500	2.5	0.500	1.25	C-2R	Clair	2000	
B24003200	3.5	0.200	0.7	C-2R	Clair	2000	
B24004301	4	0.300	1.2	C-2R	Clair	2000	
B24004300	4.8	0.300	1.45	C-2R	Clair	2000	
B24006050	6	0.050	0.3	C-2V	Clair	2000	
B24006100	6	0.100	0.6	C-2R	Clair	2000	
B24006180	6	0.180	1.1	C-2V	Clair	2000	
B24006300	6	0.300	1.8	C-2R	Clair	2000	640
B24006350	6	0.350	2.1	C-2R	Clair	2000	
B24006500	6	0.500	3	C-2R	Clair	2000	641
B24006830	6	0.830	5	C-2R	Clair	2000	
B24006999	6	1.000	6	C-2R	Clair	2000	
B24006160	6.3	0.160	1	C-2V	Clair	2000	
B24006150	6.5	0.150	0.9	C-2R	Clair	2000	
B24006301	6.5	0.300	1.95	C-2R	Clair	2000	
B24007100	7	0.100	0.7	C-2V	Clair	2000	
B24007300	7	0.300	2.1	C-2R	Clair	2000	
B24010050	8-10	0.050		C-2V	Clair	2000	
B24012050	12	0.050	0.6	C-2V	Clair	2000	
B24012100	12	0.100	1.2	C-2V	Clair	2000	
B24012165	12	0.165	2	C-2V	Clair	2000	
B24012185	12	0.185	2.2	C-2V	Clair	2000	643
B24012200	12	0.200	2.4	C-2R	Clair	2000	
B24012250	12	0.250	3	C-2R	Clair	2000	
B24012333	12	0.333	4	C-2R	Clair	2000	

# Lampes Ba9s

## Sphérique

### G11X24mm

Numéro d'article	Voltage	Courant (A)	Wattage	Filament	Teinte	Durée de vie (h)	Code US
B24014060	14	0.060	0.84	C-2V	Clair	2000	
B24014120	14.4	0.120	1.7	C-2V	Clair	2000	
B24018100	18	0.100	1.8	C-2V	Clair	2000	
B24024050	24	0.050	1.2	C-2F	Clair	2000	
B24024080	24	0.080	2	C-2F	Clair	2000	
B24024100	24	0.100	2.4	C-2F	Clair	2000	
B24024120	24	0.120	2.8	C-2F	Clair	2000	
B24024125	24	0.125	3	C-2F	Clair	2000	
B24024208	24	0.208	5	C-2F	Clair	2000	
B24028050	28	0.050	1.4	C-2F	Clair	2000	
B24028070	28	0.070	2	C-2F	Clair	2000	
B24030040	30	0.040	1.2	C-2F	Clair	2000	
B24030050	30	0.050	1.5	C-2F	Clair	2000	
B24030065	30	0.065	2	C-2F	Clair	2000	
B24030100	30	0.100	3	C-2F	Clair	2000	
B24035050	35	0.050	1.75	C-2F	Clair	2000	
B24048050	48	0.050	2.4	C-2F	Clair	2000	
B24060030	60	0.030	1.8	C-2F	Clair	2000	

# Lampes Ba9s

## Sphérique

### G15X29mm



Numéro d'article	Voltage	Courant (A)	Wattage	Filament	Teinte	Durée de vie (h)	Code US
B29002500	2.4	0.500	1.2	C-2R	Clair	2000	
B29002999	2.4	1.250	3	C-2R	Clair	2000	
B29002501	2.5	0.500	1.25	C-2R	Clair	2000	
B29002502	2.5	0.500	1.25	C-2R	Clair	10000	
B29003600	3.6	0.600	2.2	C-2R	Clair	200	
B29006180	6	0.180	1.1	C-2V	Clair	2000	
B29006200	6	0.200	1.2	C-2V	Clair	2000	
B29006300	6	0.300	1.8	C-2V	Clair	2000	
B29006350	6	0.350	2.1	C-2R	Clair	2000	
B29006400	6	0.400	0.24	C-2R	Clair	2000	
B29006500	6	0.500	3	C-2R	Clair	2000	
B29006500BL	6	0.500	3	Clignotante	Clair	500	
B29006667	6	0.667	4	C-2R	Clair	2000	
B29006830	6	0.830	5	C-2R	Clair	2000	
B29006999	6	1.000	6	C-2R	Clair	2000	
B29006320	6.3	0.320	2	C-2R	Clair	2000	
B29007300BL	7	0.300	2.1	Clignotante	Clair	2000	
B29007410	7	0.410	3	C-2R	Clair	2000	
B29010400	10	0.400	4	C-2R	Clair	2000	
B29012125	12	0.125	1.5	C-2R	Clair	2000	
B29012250	12	0.250	3	C-2V	Clair	2000	
B29012333	12	0.333	4	C-2R	Clair	2000	
B29012417	12	0.417	5	C-2R	Clair	2000	
B29012500	12	0.500	6	C-2R	Clair	2000	
B29012625	12	0.625	7.5	C-2R	Clair	2000	
B29012833	12	0.833	10	C-2V	Clair	2000	
B29014120	14	0.120	1.7	C-2V	Clair	2000	
B29014240	14	0.240	3.4	C-2R	Clair	2000	
B29016187	16	0.187	3	C-2V	Clair	2000	

# Lampes Ba9s

## Sphérique

### G15X29mm

Numéro d'article	Voltage	Courant (A)	Wattage	Filament	Teinte	Durée de vie (h)	Code US
B29017175	17	0.175	3	C-2V	Clair	2000	
B29020250	20	0.250	5	C-2V	Clair	2000	
B29024050	24	0.050	1.2	C-2F	Clair	2000	
B29024080	24	0.080	2	C-2F	Clair	2000	
B29024125	24	0.125	3	C-2F	Clair	2000	
B29024165	24	0.165	4	C-2F	Clair	2000	
B29024208	24	0.208	5	C-2F	Clair	2000	
B29024250	24	0.250	6	C-2R	Clair	2000	
B29028170	28	0.170	5	C-2F	Clair	2000	
B29030040	30	0.040	1.2	C-2F	Clair	2000	
B29030065	30	0.065	2	C-2F	Clair	2000	
B29030080	30	0.080	2.4	C-2F	Clair	2000	
B29030100	30	0.100	3	C-2F	Clair	2000	
B29030165	30	0.165	5	C-2F	Clair	2000	
B29048060	48	0.060	3	C-2F	Clair	2000	
B29048105	48	0.105	5	C-2F	Clair	2000	
B29060085	60	0.085	5	C-2F	Clair	2000	
B29130020	130	0.020	2.6	CC-2F	Clair	2000	

**Lampes Ba10s**  
**Tube**  
**T10X28mm**

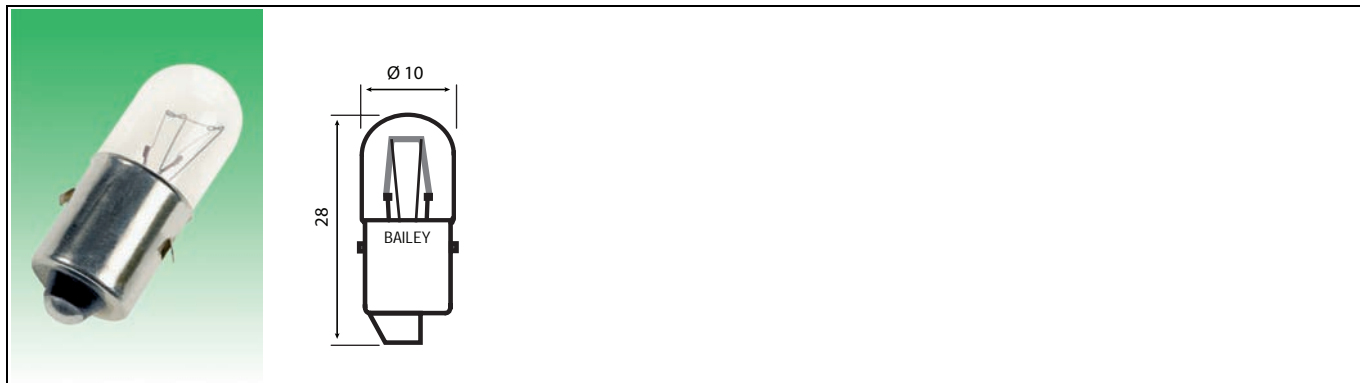

Numéro d'article	Voltage	Courant (A)	Wattage	Filament	Teinte	Durée de vie (h)	Code US
BS28006300	6	0.300	1.8	C-2R	Clair	2500	
BS28012165	12	0.165	2	C-2F	Clair	2500	
BS28012250	12	0.250	3	C-2V	Clair	1500	
BS28024125	24	0.125	3	C-2F	Clair	2500	
BS28030067	30	0.067	2	C-2F	Clair	5000	
BS28030100	30	0.100	3	C-2F	Clair	5000	
BS28048062	48	0.062	3	CC-2F	Clair	2500	
BS28065046	65	0.046	3	CC-2F	Clair	2500	
BS28065085	65	0.085	5.5	CC-2F	Clair	1000	
BS28080040	70-80	0.040	3	CC-2F	Clair	1000	
BS28130020	130	0.020	2.6	CC-3A	Clair	1000	

# Lampes E10 Tube T9X23mm

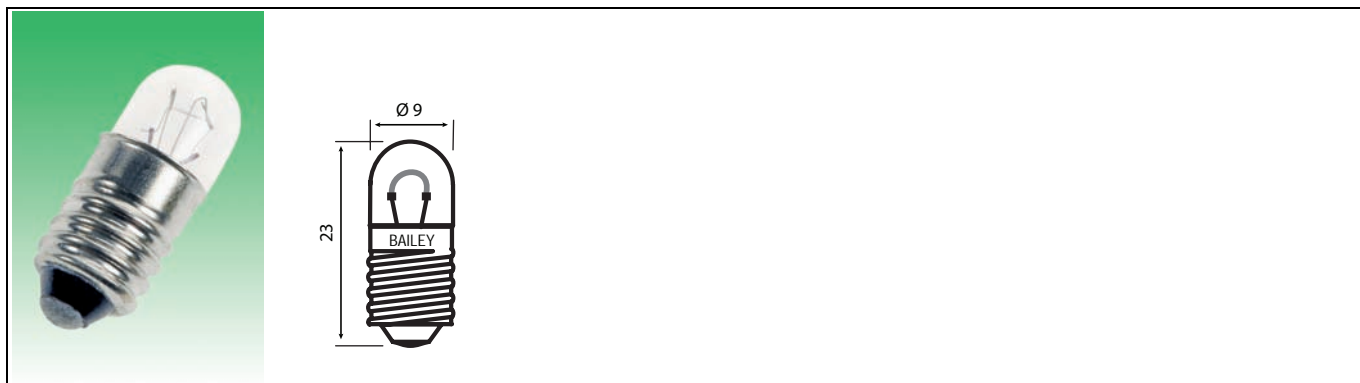

Numéro d'article	Voltage	Courant (A)	Wattage	Filament	Teinte	Durée de vie (h)	Code US
E23001220	1.2	0.220	0.26	C-2R	Clair	2000	
E23002400	2.2	0.400	0.9	C-2R	Clair	2000	
E23002200	2.5	0.200	0.5	C-2R	Clair	2000	
E23002300	2.5	0.300	0.75	C-2R	Clair	2000	
E23003301	3.3	0.300	1	C-2R	Clair	2000	
E23003304	3.7	0.300	1.1	C-2R	Clair	2000	
E23004250	4	0.250	1	C-2R	Clair	2000	
E23004300	4	0.300	1.2	C-2R	Clair	2000	
E23006050	6	0.050	0.3	C-2V	Clair	2000	
E23006100	6	0.100	0.6	C-2V	Clair	2000	
E23006180	6	0.180	1.1	C-2V	Clair	2000	
E23006200	6	0.200	1.2	C-2V	Clair	2000	
E23006333	6	0.333	2	C-2R	Clair	2000	
E23006350	6	0.350	2.1	C-2R	Clair	2000	
E23006500	6	0.500	3	C-2R	Clair	2000	
E23006150	6.3	0.150	1.1	C-2V	Clair	2000	
E23006320	6.3	0.320	2	C-2R	Clair	2000	
E23015002	12-15		2	C-2V	Clair	2000	
E23012020	12	0.020	0.25	C-2V	Clair	2000	
E23012050	12	0.050	0.6	C-2V	Clair	2000	
E23012100	12	0.100	1.2	C-2V	Clair	2000	
E23012120	12	0.120	1.45	C-2V	Clair	2000	
E23012165	12	0.165	2	C-2V	Clair	2000	
E23012250	12	0.250	3	C-2R	Clair	2000	
E23015050	15	0.050	0.75	C-2V	Clair	2000	
E23015140	15	0.140	2.1	C-2V	Clair	2000	
E23018100	18	0.100	1.8	C-2V	Clair	2000	
E23024025	24	0.025	0.6	C-2F	Clair	2000	
E23024040	24	0.040	1	C-2F	Clair	2000	

# Lampes E10

## Tube

### T9X23mm

Numéro d'article	Voltage	Courant (A)	Wattage	Filament	Teinte	Durée de vie (h)	Code US
E23024050	24	0.050	1.2	C-2F	Clair	2000	
E23024060	24	0.060	1.5	C-2F	Clair	2000	
E23024080	24	0.080	2	C-2F	Clair	2000	
E23024125	24	0.125	3	C-2F	Clair	2000	
E23028040	28	0.040	1.1	C-2F	Clair	2000	
E23028080	28	0.080	2.2	C-2F	Clair	2000	
E23030033	30	0.033	1	C-2F	Clair	2000	
E23030040	30	0.040	1.2	C-2F	Clair	2000	
E23030050	30	0.050	1.5	C-2F	Clair	2000	
E23030065	30	0.065	2	C-2F	Clair	2000	
E23030080	30	0.080	2.4	C-2F	Clair	2000	
E23030100	30	0.100	3	C-2F	Clair	2000	
E23036050	36	0.050	1.8	C-2F	Clair	2000	
E23036055	36	0.055	2	C-2F	Clair	2000	
E23036083	36	0.083	3	C-2F	Clair	2000	
E23042048	42	0.048	2	C-2F	Clair	2000	
E23048020	48	0.020	1	C-2F	Clair	2000	
E23048025	48	0.025	1.2	C-2F	Clair	2000	
E23048040	48	0.040	2	C-2F	Clair	2000	
E23048060	48	0.060	3	C-2F	Clair	2000	
E23060020	60	0.020	1.2	C-2F	Clair	2000	
E23060035	60	0.035	2.1	C-2F	Clair	2000	
E23060040	60	0.040	2.4	C-2F	Clair	2000	
E23060050	60	0.050	3	C-2F	Clair	2000	
E23070029	70	0.029	2	C-2F	Clair	2000	
E23080020	80	0.020	1.6	C-2F	Clair	2000	
E23080040	80	0.040	3	C-2F	Clair	2000	
E23130020	130	0.020	2.6	C-5A	Clair	2000	
E23220014	220	0.014	3	CC-7A	Clair	2000	
E23240017	240	0.017	4	CC-7A	Clair	2000	

# Lampes E10

## Tube

### T10X28mm



Numéro d'article	Voltage	Courant (A)	Wattage	Filament	Teinte	Durée de vie (h)	Code US
E28001500	1.5	0.500	0.75	C-2R	Clair	2000	
E28002100	2.5	0.100	0.25	C-2R	Clair	2000	
E28002200	2.5	0.200	0.5	C-2R	Clair	2000	
E28002300	2.5	0.300	0.75	C-2R	Clair	2000	
E28002500	2.5	0.500	1.25	C-2R	Clair	2000	
E28002999	2.5	1.000	2.5	C-2R	Clair	2000	
E28003300	3	0.300	0.9	C-2R	Clair	2000	
E28003200	3.5	0.200	0.7	C-2R	Clair	2000	
E28003700	3.5	0.700	2.4	C-2R	Clair	2000	
E28003070	3.8	0.070	0.3	C-2R	Clair	2000	
E28004040	4	0.040	0.16	C-2V	Clair	2000	
E28004100	4	0.100	0.4	C-2R	Clair	2000	
E28004250	4	0.250	1	C-2R	Clair	2000	
E28004300	4	0.300	1.2	C-2R	Clair	2000	
E28004400	4	0.400	1.6	C-2R	Clair	2000	
E28004500	4	0.500	2	C-2R	Clair	2000	
E28004600	4	0.600	2.4	C-2R	Clair	2000	
E28004750	4	0.750	3	C-2R	Clair	2000	
E28004301	4.5	0.300	1.35	C-2R	Clair	2000	
E28005090	5	0.090	0.45	C-2R	Clair	2000	
E28005150	5	0.150	0.75	C-2R	Clair	2000	
E28006050	6	0.050	0.3	C-2V	Clair	2000	
E28006060	6	0.060	0.36	C-2V	Clair	2000	411
E28006075	6	0.075	0.45	C-2R	Clair	2000	
E28006100	6	0.100	0.6	C-2R	Clair	2000	
E28006180	6	0.180	1.1	C-2V	Clair	2000	
E28006200	6	0.200	1.2	C-2V	Clair	2000	
E28006301	6	0.300	1.8	C-2R	Clair	2000	
E28006333	6	0.333	2	C-2R	Clair	2000	

# Lampes E10

## Tube

### T10X28mm

Numéro d'article	Voltage	Courant (A)	Wattage	Filament	Teinte	Durée de vie (h)	Code US
E28006350	6	0.350	2.1	C-2R	Clair	2000	
E28006500	6	0.500	3	C-2R	Clair	2000	
E28006700	6	0.700	4.2	C-2R	Clair	2000	
E28006830	6	0.830	5	C-2R	Clair	2000	
E28006999	6	1.000	6	C-2R	Clair	2000	
E28006101	6.3	0.100	0.63	C-2V	Clair	2000	
E28006150	6.3	0.150	1.1	C-2V	Clair	2000	40
E28006250	6.3	0.250	1.6	C-2R	Clair	2000	46
E28006302	6.3	0.300	1.89	C-2R	Clair	2000	
E28006320	6.3	0.320	2	C-2R	Clair	2000	
E28006102	6.5	0.100	0.65	C-2V	Clair	2000	
E28006152	6.5	0.150	1	C-2V	Clair	2000	
E28006300	6.5	0.300	2	C-2R	Clair	2000	
E28007100	7	0.100	0.7	C-2V	Clair	2000	
E28007300	7	0.300	2.1	C-2R	Clair	2000	
E28007320	7	0.320	2.2	C-2R	Clair	2000	
E28008100	8	0.100	0.8	C-2V	Clair	2000	
E28008150	8	0.150	1.2	C-2V	Clair	2000	
E28008300	8	0.300	2.4	C-2V	Clair	2000	
E28008375	8	0.375	3	C-2V	Clair	2000	
E28010050	10	0.050	0.5	C-2V	Clair	2000	
E28010200	10	0.200	2	C-2V	Clair	2000	
E28015002	12-15		2	C-2V	Clair	2000	
E28012020	12	0.020	0.25	C-2V	Clair	2000	
E28012050	12	0.050	0.6	C-2V	Clair	2000	
E28012100	12	0.100	1.2	C-2V	Clair	2000	
E28012120	12	0.120	1.4	C-2V	Clair	2000	
E28012125	12	0.125	1.5	C-2V	Clair	2000	
E28012165	12	0.165	2	C-2V	Clair	2000	
E28012183	12	0.183	2.2	C-2V	Clair	2000	1309
E28012200	12	0.200	2.4	C-2V	Clair	2000	
E28012250	12	0.250	3	C-2V	Clair	2000	
E28012415	12	0.415	5	C-2V	Clair	2000	
E28014080	14	0.080	1.1	C-2V	Clair	2000	
E28014100	14	0.100	1.4	C-2V	Clair	2000	
E28014200	14	0.200	2.8	C-2V	Clair	2000	1487
E28015050	15	0.050	0.75	C-2F	Clair	2000	
E28015133	15	0.133	2	C-2V	Clair	2000	
E28015200	15	0.200	3	C-2V	Clair	2000	

# Lampes E10

## Tube

### T10X28mm

Numéro d'article	Voltage	Courant (A)	Wattage	Filament	Teinte	Durée de vie (h)	Code US
E28016050	16	0.050	0.8	C-2V	Clair	2000	
E28016100	16	0.100	1.6	C-2V	Clair	2000	
E28018020	18	0.020	0.36	C-2V	Clair	2000	
E28018100	18	0.100	1.8	C-2V	Clair	2000	
E28018110	18	0.110	2	C-2V	Clair	2000	
E28018170	18	0.170	3	C-2V	Clair	2000	
E28019040	19	0.040	0.75	C-2V	Clair	2000	
E28019090	19	0.090	1.7	C-2V	Clair	2000	
E28030002	24-30		2	C-2F	Clair	2000	
E28024025	24	0.025	0.6	C-2F	Clair	2000	
E28024040	24	0.040	1	C-2F	Clair	2000	
E28024050	24	0.050	1.2	C-2F	Clair	2000	
E28024060	24	0.060	1.5	C-2F	Clair	2000	
E28024080	24	0.080	2	C-2F	Clair	2000	
E28024100	24	0.100	2.4	C-2F	Clair	2000	
E28024125	24	0.125	3	C-2F	Clair	2000	
E28024165	24	0.165	4	C-2F	Clair	2000	
E28024210	24	0.210	5	C-2F	Clair	2000	
E28028040	28	0.040	1.1	C-2F	Clair	2000	
E28028050	28	0.050	1.4	C-2F	Clair	2000	
E28028070	28	0.070	2	C-2F	Clair	2000	
E28028100	28	0.100	2.8	C-2F	Clair	2000	
E28028170	28	0.170	4.8	C-2F	Clair	2000	
E28030040	30	0.040	1.2	C-2F	Clair	2000	
E28030050	30	0.050	1.5	C-2F	Clair	2000	
E28030065	30	0.065	2	C-2F	Clair	2000	
E28030080	30	0.080	2.4	C-2F	Clair	2000	
E28030100	30	0.100	3	C-2F	Clair	2000	
E28030165	30	0.165	5	C-2F	Clair	2000	
E28045002	36-45		2	C-2F	Clair	2000	
E28045004	36-45		4	C-2F	Clair	2000	
E28036033	36	0.033	1.2	C-2F	Clair	2000	
E28036050	36	0.050	1.8	C-2F	Clair	2000	
E28036055	36	0.055	2	C-2F	Clair	2000	
E28036085	36	0.085	3	C-2F	Clair	2000	1177
E28048002	42-48		2	C-2F	Clair	2000	
E28042045	42	0.045	2	C-2F	Clair	2000	
E28042070	42	0.070	3	C-2F	Clair	2000	
E28042120	42	0.120	5	C-2F	Clair	2000	

# Lampes E10

## Tube

### T10X28mm

Numéro d'article	Voltage	Courant (A)	Wattage	Filament	Teinte	Durée de vie (h)	Code US
E28060002	48-60		2	C-2F	Clair	2000	
E28060004	48-60		4	C-2F	Clair	2000	
E28060005	48-60		5	C-2F	Clair	2000	
E28048020	48	0.020	1	C-2F	Clair	2000	
E28048040	48	0.040	2	C-2F	Clair	2000	
E28048050	48	0.050	2.4	C-2F	Clair	2000	
E28048060	48	0.060	3	C-2F	Clair	2000	
E28048080	48	0.080	4	C-2F	Clair	2000	
E28048100	48	0.100	4.8	C-2F	Clair	2000	1823
E28048105	48	0.105	5	C-2F	Clair	2000	
E28050050	50	0.050	2.5	C-2F	Clair	2000	
E28052060	52	0.060	3	C-2F	Clair	2000	
E28060020	60	0.020	1.2	C-2F	Clair	2000	
E28060030	60	0.030	1.8	C-2F	Clair	2000	
E28060033	60	0.033	2	C-2F	Clair	2000	
E28060040	60	0.040	2.4	C-2F	Clair	2000	
E28060050	60	0.050	3	C-2F	Clair	2000	
E28060060	60	0.060	3.6	C-2F	Clair	2000	
E28060070	60	0.070	4	C-2F	Clair	2000	
E28060085	60	0.085	5	C-2F	Clair	2000	
E28070020	70	0.020	1.4	C-2F	Clair	2000	
E28070040	70	0.040	2.8	C-2F	Clair	2000	
E28080040	70-80	0.040		C-2F	Clair	2000	
E28080025	80	0.025	2	C-2F	Clair	2000	
E28080035	80	0.035	3	C-3A	Clair	2000	
E28085035	85	0.035	3	C-3A	Clair	2000	
E28110027	110	0.027	3	C-5A	Clair	2000	
E28130015	130	0.015	2	C-5A	Clair	2000	
E28130020	130	0.020	2.6	C-5A	Clair	2000	
E28130021	130	0.020	2.6	CC-6A	Clair	5000	
E28130038	130	0.038	5	C-5A	Clair	2000	
E28160020	160	0.020	3.2	C-5A	Clair	2000	
E28220009	220	0.009	2	CC-7A	Clair	2000	
E28220014	220	0.014	3	C-7A	Clair	2000	
E28220018	220	0.018	4	CC-6A	Clair	2000	
E28220023	220	0.023	5	C-7A	Clair	2000	
E28230013	230	0.013	3	C-7A	Clair	1500	
E28230022	230	0.022	5	CC-7A	Clair	2000	
E28240010	240	0.010	2.4	CC-7A	Clair	2000	

**Lampes E10****Tube****T10X28mm**

Numéro d'article	Voltage	Courant (A)	Wattage	Filament	Teinte	Durée de vie (h)	Code US
E28240012	240	0.012	3	CC-7A	Clair	2000	
E28240004	240	0.015	3	C-7A	Clair	2000	
E28240017	240	0.017	4	C-7A	Clair	2000	

**Lampes E10  
Tube  
T10X38mm**



Numéro d'article	Voltage	Courant (A)	Wattage	Filament	Teinte	Durée de vie (h)	Code US
E38030060	30	0.060	1.8	C-2F	Clair	2000	
E38030100	30	0.100	3	C-2F	Clair	2000	
E38048060	48	0.060	2.8	C-2F	Clair	2000	
E38060030	60	0.030	1.8	C-2F	Clair	2000	
E38060050	60	0.050	3	C-2F	Clair	2000	
E38060085	60	0.085	5	C-2F	Clair	2000	
E38130030	130	0.030	4	C-5A	Clair	2000	
E38160025	160	0.025	4	C-5A	Clair	2000	
E38220014	220	0.014	3	C-7A	Clair	1000	
E38230018	230	0.018	4	C-7A	Clair	2000	

## Lampes E10

### Tube

T10X50mm



Numéro d'article	Voltage	Courant (A)	Wattage	Filament	Teinte	Durée de vie (h)	Code US
E50024125	24	0.125	3	C-2F	Clair	2000	
E50030100	30	0.100	3	C-2F	Clair	2000	
E50060050	60	0.050	3	C-2F	Clair	2000	
E50130030	130	0.030	4	C-5A	Clair	2000	
E50160025	160	0.025	4	C-5A	Clair	2000	
E50230018	230	0.018	4	CC-7A	Clair	1000	

**Lampes E10**  
**Tube**  
**T16X38mm**



Numéro d'article	Voltage	Courant (A)	Wattage	Filament	Teinte	Durée de vie (h)	Code US
TE038012005	12	0.415	5	C-2R	Clair	2000	
TE038024005	24	0.210	5	C-2F	Clair	2000	
TE038048005	48	0.105	5	C-2F	Clair	2000	
TE038160005	160	0.030	5	C-5A	Clair	2000	
TE038255005	255	0.020	5	C-7A	Clair	2000	
TE038260010	220-260		6-10	C-7A	Clair	2000	

## Lampes E10

### Tube

T16X43mm



Numéro d'article	Voltage	Courant (A)	Wattage	Filament	Teinte	Durée de vie (h)	Code US
TE043024005	24	0.210	5	C-2F	Clair	2000	
TE043027005	27	0.185	5	C-2V	Clair	2000	
TE043130010	130	0.077	10	C-5A	Clair	2000	
TE043250007	250	0.028	7	C-7A	Clair	2000	
TE043260010	220-260	0.038	6-10	C-7A	Clair	2000	

**Lampes E10**  
**Lampe tube pour télescriteur**  
**T6.8X35mm**

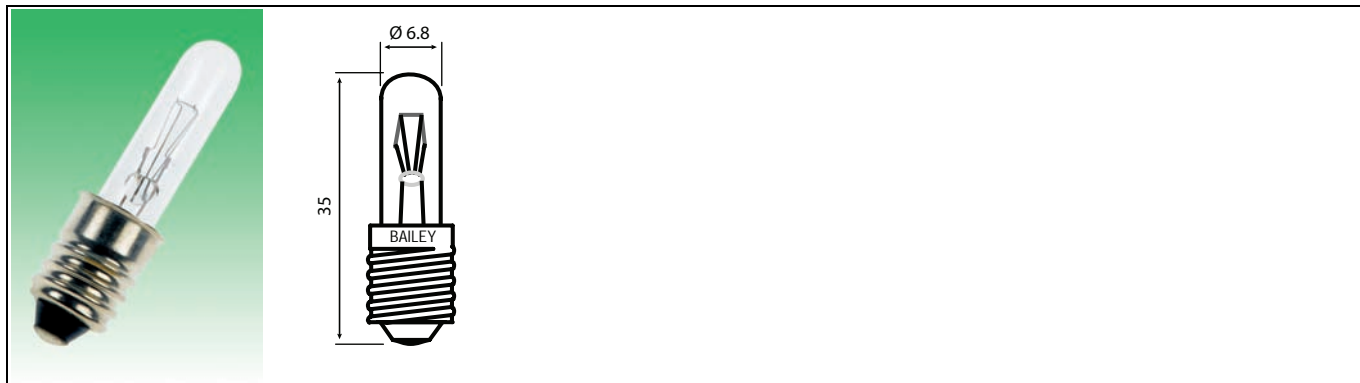

Numéro d'article	Voltage	Courant (A)	Wattage	Filament	Teinte	Durée de vie (h)	Code US
ET35024100	24	0.100	2.4	CC-2F	Clair	2000	
ET35050055	50	0.055	3	CC-2F	Clair	2000	
ET35060060	60	0.060	3.6	CC-2F	Clair	2000	

**Lampes E10**  
**Lampe tube Sperry**  
**T16X43mm**

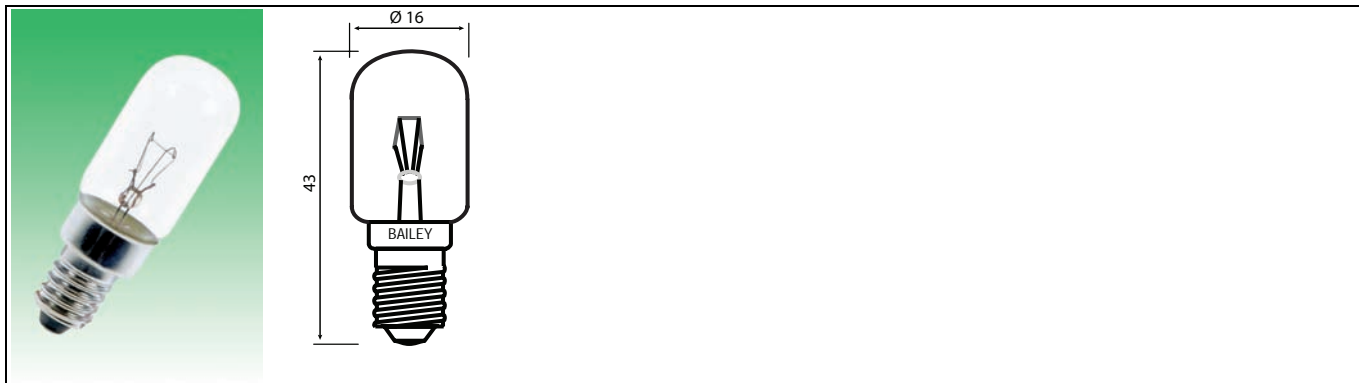

Numéro d'article	Voltage	Courant (A)	Wattage	Filament	Teinte	Durée de vie (h)	Code US
VS10045008	45	0.178	8	C-2F	Clair	1000	
VS10045008R	45	0.178	8	C-2F	Rouge	1000	
VS10070008	70	0.114	8	C-2F	Clair	1000	
VS10070008R	70	0.114	8	C-2F	Rouge	1000	

**Lampes E10**  
**Sphérique**  
**G11X24mm**



Numéro d'article	Voltage	Courant (A)	Wattage	Filament	Teinte	Durée de vie (h)	Code US
E24001250	1.25	0.250	0.3	C-2R	Clair	2000	
E24001150	1.3	0.150	0.19	C-2R	Clair	2000	
E24001090	1.5	0.090	0.13	C-2R	Clair	2000	
E24001151	1.5	0.150	0.23	C-2R	Clair	2000	
E24001200	1.5	0.200	0.3	C-2R	Clair	2000	
E24001300	1.5	0.300	0.45	C-2R	Clair	2000	
E24002301	2	0.300	0.6	C-2R	Clair	2000	
E24002200	2.2	0.200	0.44	C-2R	Clair	2000	
E24002060	2.5	0.060	0.15	C-2R	Clair	2000	
E24002100	2.5	0.100	0.25	C-2R	Clair	2000	
E24002201	2.5	0.200	0.5	C-2R	Clair	2000	
E24002300	2.5	0.300	0.75	C-2R	Clair	2000	
E24002500	2.5	0.500	1.25	C-2R	Clair	2000	
E24003150	3.5	0.150	0.52	C-2R	Clair	2000	
E24003200	3.5	0.200	0.7	C-2R	Clair	2000	
E24003300	3.5	0.300	1.15	C-2R	Clair	2000	
E24003070	3.8	0.070	0.27	C-2R	Clair	2000	
E24003301	3.8	0.300	1.14	C-2R	Clair	2000	
E24004040	4	0.040	0.16	C-2V	Clair	2000	
E24004300	4	0.300	1.2	C-2R	Clair	2000	
E24004500	4	0.500	2	C-2R	Clair	2000	
E24005300	4.8	0.300	1.44	C-2R	Clair	2000	
E24005500	4.8	0.500	2.4	C-2R	Clair	2000	
E24006040	6	0.040	0.24	C-2V	Clair	2000	
E24006050	6	0.050	0.3	C-2R	Clair	2000	
E24006100	6	0.100	0.6	C-2V	Clair	2000	
E24006151	6	0.150	0.9	C-2V	Clair	2000	
E24006180	6	0.180	1.1	C-2V	Clair	2000	
E24006333	6	0.333	2	C-2R	Clair	2000	

# Lampes E10

## Sphérique

### G11X24mm

Numéro d'article	Voltage	Courant (A)	Wattage	Filament	Teinte	Durée de vie (h)	Code US
E24006350	6	0.350	2.1	C-2R	Clair	2000	
E24006500	6	0.500	3	C-2R	Clair	2000	
E24006600	6	0.600	3.6	C-2R	Clair	2000	
E24006830	6	0.830	5	C-2R	Clair	2000	
E24006300	6.2	0.300	1.86	C-2R	Clair	2000	
E24006484	6.2	0.484	3	C-2R	Clair	2000	
E24006060	6.3	0.060	0.38	C-2V	Clair	2000	
E24006150	6.3	0.150	0.95	C-2V	Clair	2000	
E24006250	6.3	0.250	1.5	C-2R	Clair	2000	
E24006301	6.5	0.300	1.95	C-2R	Clair	2000	
E24007100	7	0.100	0.7	C-2V	Clair	2000	
E24007300	7	0.300	2.1	C-2R	Clair	2000	
E24010050	8-10	0.050		C-2V	Clair	2000	
E24012040	12	0.040	0.48	C-2V	Clair	2000	
E24012050	12	0.050	0.6	C-2V	Clair	2000	
E24012100	12	0.100	1.2	C-2V	Clair	2000	
E24012165	12	0.165	2	C-2V	Clair	2000	
E24012185	12	0.185	2.2	C-2V	Clair	2000	987
E24012200	12	0.200	2.4	C-2V	Clair	2000	
E24012250	12	0.250	3	C-2V	Clair	2000	
E24012400	12	0.400	4.8	C-2V	Clair	2000	
E24014060	14	0.060	0.84	C-2V	Clair	2000	
E24018100	18	0.100	1.8	C-2V	Clair	2000	
E24019040	19	0.040	0.76	C-2V	Clair	2000	
E24019100	19	0.100	1.9	C-2V	Clair	2000	
E24024050	24	0.050	1.2	C-2F	Clair	2000	
E24024080	24	0.080	2	C-2F	Clair	2000	
E24024100	24	0.100	2.4	C-2F	Clair	2000	
E24024125	24	0.125	3	C-2F	Clair	2000	
E24024210	24	0.210	5	C-2F	Clair	2000	
E24028050	28	0.050	1.4	C-2F	Clair	2000	
E24030065	30	0.065	2	C-2F	Clair	2000	
E24030100	30	0.100	3	C-2F	Clair	2000	
E24036050	36	0.050	1.75	C-2F	Clair	2000	
E24048030	48	0.030	1.44	C-2F	Clair	2000	
E24048050	48	0.050	2.4	C-2F	Clair	2000	
E24060040	60	0.040	2.4	C-2F	Clair	2000	

**Lampes E10**  
**Sphérique**  
**G15X29mm**



Numéro d'article	Voltage	Courant (A)	Wattage	Filament	Teinte	Durée de vie (h)	Code US
E29002625	2.4	0.625	1.5	C-2R	Clair	2000	
E29002998	2.4	1.000	2.4	C-2R	Clair	2000	
E29002997	2.4	1.250	3	C-2R	Clair	2000	
E29002350	2.5	0.350	0.88	C-2R	Clair	2000	
E29002500	2.5	0.500	1.25	C-2R	Clair	2000	
E29002999	2.5	1.250	3	C-2R	Clair	2000	
E29002270	2.6	0.270	0.7	C-2R	Clair	2000	
E29003200	3.5	0.200	0.7	C-2R	Clair	2000	
E29004600	4	0.600	2.4	C-2R	Clair	2000	
E29004700	4	0.700	2.8	C-2R	Clair	2000	
E29005500	4.8	0.500	2.4	C-2R	Clair	2000	
E29004300	4.9	0.300	1.5	C-2R	Clair	2000	
E29005050	5	0.050	0.25	C-2R	Clair	2000	
E29005100	5	0.100	0.5	C-2R	Clair	2000	
E29005150	5	0.150	0.75	C-2R	Clair	2000	
E29006050	6	0.050	0.3	C-2R	Clair	2000	
E29006350	6	0.350	2.1	C-2R	Clair	2000	
E29006400	6	0.400	2.4	C-2R	Clair	2000	
E29006450	6	0.450	2.7	C-2R	Clair	2000	
E29006500	6	0.500	3	C-2R	Clair	2000	
E29006500BL	6	0.500	3		Clair	2000	
E29006830	6	0.830	5	C-2R	Clair	2000	
E29006999	6	1.000	6	C-2R	Clair	2000	
E29006250	6.3	0.250	1.6	C-2R	Clair	2000	
E29006320	6.3	0.320	2	C-2R	Clair	2000	
E29007240	7	0.240	1.44	C-2R	Clair	2000	
E29007300	7	0.300	2.1	C-2R	Clair	2000	
E29008450	8	0.450	3.6	C-2R	Clair	2000	
E29012100	12	0.100	1.2	C-2V	Clair	2000	

# Lampes E10

## Sphérique

### G15X29mm

Numéro d'article	Voltage	Courant (A)	Wattage	Filament	Teinte	Durée de vie (h)	Code US
E29012170	12	0.170	2	C-2V	Clair	2000	
E29012200	12	0.200	2.4	C-2V	Clair	2000	
E29012250	12	0.250	3	C-2V	Clair	2000	
E29012330	12	0.330	4	C-2R	Clair	2000	
E29012410	12	0.410	5	C-2V	Clair	2000	
E29012500	12	0.500	6	C-2V	Clair	2000	
E29012500GR	12	0.500	6	C-2V	Givré	2000	
E29014500	14	0.500	7	C-2V	Clair	2000	
E29016188	16	0.188	3	C-2V	Clair	2000	
E29019040	19	0.040	0.75	C-2V	Clair	2000	
E29024050	24	0.050	1.2	C-2F	Clair	2000	
E29024080	24	0.080	2	C-2F	Clair	2000	
E29024125	24	0.125	3	C-2F	Clair	2000	
E29024150	24	0.150	3.6	C-2F	Clair	2000	
E29024210	24	0.210	5	C-2F	Clair	2000	
E29028150	28	0.150	4.2	C-2F	Clair	2000	
E29030100	30	0.100	3	C-2F	Clair	2000	
E29030165	30	0.165	5	C-2F	Clair	2000	
E29035050	35	0.050	1.75	C-2F	Clair	2000	
E29036140	36	0.140	5	C-2F	Clair	2000	
E29042050	42	0.050	2.1	C-2F	Clair	2000	
E29048060	48	0.060	3	C-2F	Clair	2000	
E29048105	48	0.105	5	C-2F	Clair	2000	
E29060083	60	0.083	5	C-2F	Clair	2000	
E29130020	130	0.020	2.6	CC-3A	Clair	2000	

**Lampes E10**  
**Sphérique**  
**G18X32mm**



Numéro d'article	Voltage	Courant (A)	Wattage	Filament	Teinte	Durée de vie (h)	Code US
KE0320020500	2.4	0.500	1.2	C-2R	Clair	1000	
KE0320020625	2.4	0.625	1.5	C-2R	Clair	1000	
KE0320020833	2.4	0.833	2	C-2R	Clair	500	
KE0320020900	2.4	0.900	2.16	C-2R	Clair	500	
KE0320021000	2.4	1.000	2.44	C-2R	Clair	250	
KE0320021250	2.4	1.250	3	C-2R	Clair	250	
KE0320021666	2.4	1.666	4	C-2R	Clair	250	
KE0320022083	2.4	2.080	5	C-2R	Clair	500	
KE0320030448	3.75	0.448	1.68	C-2R	Clair	500	
KE0320030533	3.75	0.533	2	C-2R	Clair	500	
KE0320030666	3.75	0.666	2.5	C-2R	Clair	500	
KE0320030898	3.75	0.898	3.37	C-2R	Clair	500	
KE0320031338	3.75	1.338	5.02	C-2R	Clair	250	
KE0320040520	4.8	0.520	2.5	C-2R	Clair	1000	
KE0320041041	4.8	1.041	5	C-2R	Clair	300	
KE032006005	6	0.833	5	C-2R	Clair	500	
KE032012005	12	0.417	5	C-2V	Clair	1000	
KE032024010	24	0.417	10	C-2F	Clair	1000	
KE032028012	28	0.429	12	C-2F	Clair	1000	
KE032060010	60	0.167	10	CC-2F	Clair	2000	
KE032120010	120	0.083	10	CC-3	Clair	1000	
KE032130005	130	0.038	5	C-5A	Clair	2000	
KE032130008	130	0.062	8	CC-3	Clair	1000	

## Lampes E10

### Krypton

Lampes pour bloc de sécurité



Numéro d'article	Voltage	Courant (A)	Wattage	Filament	Teinte	V (h)	ø (mm)	l (mm)
EK0250750	2.5	0.750	1.88	C-2R	Clair	15	11	30
EK0480750	4.8	0.750	3.6	C-2R	Clair	15	11	26.5
EK2902313	2.4	0.313	0.75	C-2R	Clair	15	15	29
EK2902240	2.4	1.000	2.4	C-2R	Clair	30	15	29
EK2903360	3.6	1.000	3.6	C-2R	Clair	100	15	29
EK2904320	4	0.800	3.2	C-2R	Clair	400	15	29
EK2904400	4	1.000	4	C-2R	Clair	400	15	29
EK2906500	6	0.500	3	C-2R	Clair	15	15	29
EK3003090	3.6	0.250	0.9	C-2R	Clair	500	17	30
EK3003360	3.6	1.000	3.6	C-2R	Clair	100	17	30
EK3003560	3.75	1.500	5.6	C-2R	Clair	500	17	30
EK3006270	6	0.450	2.7	C-2R	Clair	50	17	30

# Lampes E10

## Xénon

### Lampes pour bloc de sécurité

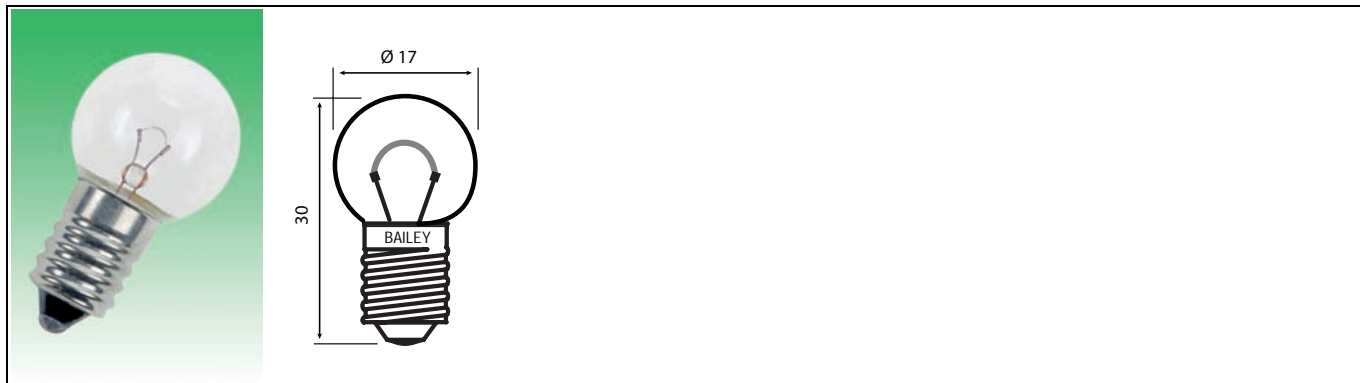

Numéro d'article	Voltage	Courant (A)	Wattage	Filament	Teinte	V (h)	ø (mm)	l (mm)
EX3024240	2.4	1.000	2.4	C-2R	Clair	100	17	30
EX3024300	2.4	1.250	3	C-2R	Clair	100	17	30
EX3036090	3.6	0.250	0.9	C-2R	Clair	500	17	30
EX3036162	3.6	0.450	1.62	C-2R	Clair	100	17	30
EX3036216	3.6	0.600	2.16	C-2R	Clair	100	17	30
EX3036360	3.6	1.000	3.6	C-2R	Clair	100	17	30
EX3037340	3.75	0.900	3.4	C-2R	Clair	500	17	30
EX3037560	3.75	1.500	5.6	C-2R	Clair	500	17	30
EX3040182	4	0.550	2.2	C-2R	Clair	500	17	30
EX3040320	4	0.800	3.2	C-2R	Clair	500	17	30
EX3048288	4.8	0.600	2.88	C-2R	Clair	500	17	30
EX3060270	6	0.450	2.7	C-2R	Clair	100	17	30
EX3060300	6	0.500	3	C-2R	Clair	500	17	30
EX3060540	6	0.900	5.4	C-2R	Clair	500	17	30
EX3060600	6	1.000	6	C-2R	Clair	500	17	30

**Lampes E10**  
**Lampes pour Torches**  
**Miniloupe**

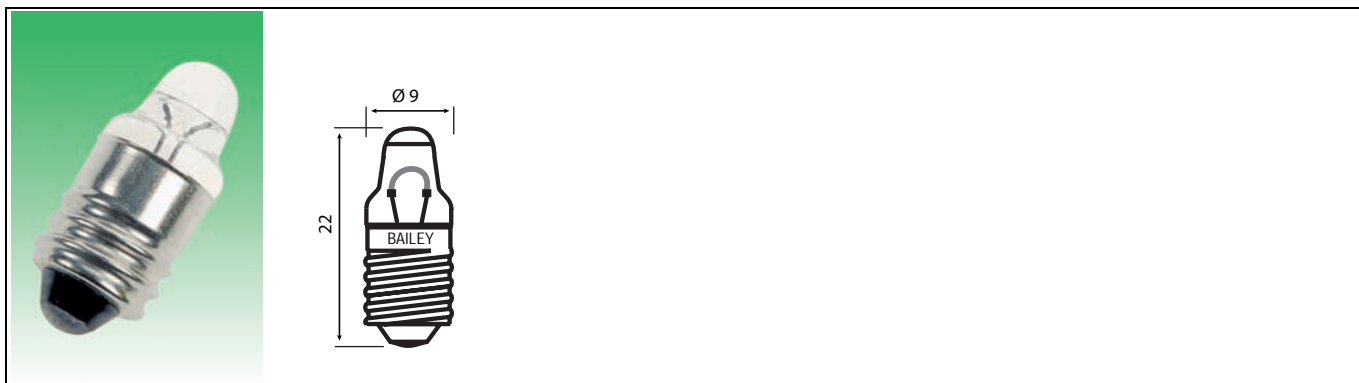

Numéro d'article	Voltage	Courant (A)	Filament	Teinte	V (h)	Code US
EL0120220	1.2	0.220	C-2R	Clair	50	112
EL0220180	2.2	0.180	C-2R	Clair	50	
EL0220250	2.2	0.250	C-2R	Clair	50	222
EL0220300	2.2	0.300	C-2R	Clair	50	
EL0225250	2.25	0.250	C-2R	Clair	5	222
EL0233270	2.33	0.270	C-2R	Clair	10	243
EL0250200	2.5	0.200	C-2R	Clair	50	
EL0250300	2.5	0.300	C-2R	Clair	50	
EL0330300	3.3	0.300	C-2R	Clair	50	
EL0350200	3.5	0.200	C-2R	Clair	50	
EL0370300	3.7	0.300	C-2R	Clair	50	
EL0380300	3.8	0.300	C-2R	Clair	50	

**Lampes E10**  
**Lampes pour Torches**  
**NF Brillant**



Numéro d'article	Voltage	Courant (A)	Filament	Teinte	V (h)	Code US
EB0220250	2.2	0.250	C-2R	Clair	50	
EB0220300	2.2	0.300	C-2R	Clair	50	
EB0220400	2.2	0.400	C-2R	Clair	50	
EB0240300	2.4	0.300	C-2R	Clair	50	
EB0240400	2.4	0.400	C-2R	Clair	50	
EB0240500	2.4	0.500	C-2R	Clair	50	
EB0250250	2.5	0.250	C-2R	Clair	50	
EB0250300	2.5	0.300	C-2R	Clair	50	
EB0330300	3.3	0.300	C-2R	Clair	50	
EB0370300	3.7	0.300	C-2R	Clair	50	
EB0480300	4.8	0.300	C-2R	Clair	50	

# P13.5s Préfocus

## Lampes pour Torches

### Olive

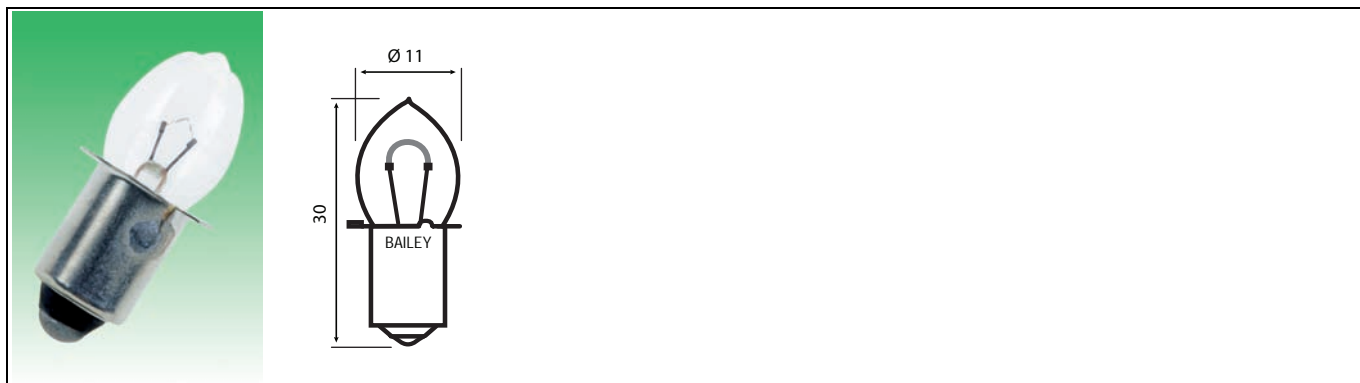

Numéro d'article	Voltage	Courant (A)	Filament	Teinte	V (h)	Code US
PR0125250	1.25	0.250	C-2R	Clair	15	
PR0190650	1.9	0.650	C-2R	Clair	10	PR8
PR0233270	2.33	0.270	C-2R	Clair	10	PR4
PR0235350	2.35	0.350	C-2R	Clair	35	PR5
PR0238500	2.38	0.500	C-2R	Clair	15	PR2
PR0247300	2.47	0.300	C-2R	Clair	30	PR6
PR0250200	2.5	0.200	C-2R	Clair	10	
PR0270150	2.7	0.150	C-2R	Clair	45	PR9
PR0360500	3.6	0.500	C-2R	Clair	15	PR3
PR0370300	3.7	0.300	C-2R	Clair	30	PR7
PR0375860	3.75	0.860	C-2R	Clair	50	PR30
PR0475500	4.75	0.500	C-2R	Clair	15	PR13
PR0480300	4.8	0.300	C-2R	Clair	15	
PR0480500	4.8	0.500	C-2R	Clair	30	PR15
PR0490300	4.9	0.300	C-2R	Clair	30	PR17
PR0595500	5.95	0.500	C-2R	Clair	15	PR12
PR0720500	7.2	0.500	C-2R	Clair	3	PR18
PR0863500	8.63	0.500	C-2R	Clair	15	PR20
PR1250250	12.5	0.250	C-2R	Clair	50	PR16

**P13.5s Préfocus**  
**Lampes pour Torches**  
**NF Brillant**



Numéro d'article	Voltage	Courant (A)	Filament	Teinte	V (h)	Code US
PB0220250	2.2	0.250	C-2R	Clair	50	
PB0220300	2.2	0.300	C-2R	Clair	50	
PB0220400	2.2	0.400	C-2R	Clair	50	
PB0240300	2.4	0.300	C-2R	Clair	50	
PB0240400	2.4	0.400	C-2R	Clair	50	
PB0250300	2.5	0.300	C-2R	Clair	30	
PB0370300	3.7	0.300	C-2R	Clair	50	

# P13.5s Préfocus

## Lampes pour Torches

### Krypton



Numéro d'article	Voltage	Courant (A)	Filament	Teinte	V (h)	Code US
PK0220470	2.2	0.470	C-2R	Clair	15	KPR104
PK0240500	2.4	0.500	C-2R	Clair	10	KPRK1
PK0240700	2.4	0.700	C-2R	Clair	13	KPR102
PK0360750	3.6	0.750	C-2R	Clair	50	KPR103
PK0360800	3.6	0.800	C-2R	Clair	15	
PK0361000	3.6	1.000	C-2R	Clair	15	
PK0401000	4	1.000	C-2R	Clair	25	KPR5984
PK0475500	4.75	0.500	C-2R	Clair	30	KPR1941
PK0480750	4.8	0.750	C-2R	Clair	15	KPR113
PK0540540	5.4	0.540	C-2R	Clair	50	
PK0600500	6	0.500	C-2R	Clair	15	
PK0600750	6	0.750	C-2R	Clair	20	KPR112
PK0720750	7.2	0.750	C-2R	Clair	20	KPR118
PK0960500	9.6	0.500	C-2R	Clair	25	
PK1200700	12	0.700	C-2R	Clair	50	
PK1440700	14.4	0.700	C-2R	Clair	15	

# Lampes Ba15d Tube T14X30mm

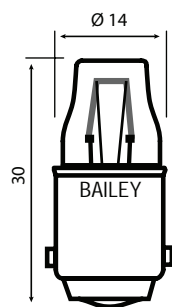

Numéro d'article	Voltage	Courant (A)	Wattage	Filament	Teinte	V (h)
B30006001	6	0.180	1.1	C-2V	Clair	2000
B30006003	6	0.500	3	C-2V	Clair	2000
B30006005	6	0.833	5	C-2V	Clair	2000
B30012001	12	0.120	1.44	C-2V	Clair	2000
B30012002	12	0.165	2	C-2V	Clair	2000
B30012003	12	0.250	3	C-2V	Clair	2000
B30012005	12	0.417	5	C-2V	Clair	2000
B300240012	24	0.050	1.2	C-2F	Clair	2000
B30024002	24	0.080	2	C-2F	Clair	2000
B30024003	24	0.125	3	C-2F	Clair	2000
B30024005	24	0.208	5	C-2F	Clair	2000
B30030002	30	0.065	2	C-2F	Clair	2000
B30030003	30	0.100	3	C-2F	Clair	2000
B30030005	30	0.167	5	C-2F	Clair	2000
B300360018	36	0.050	1.8	C-2F	Clair	2000
B30036002	36	0.055	2	C-2F	Clair	2000
B30036005	36	0.140	5	C-2F	Clair	2000
B30048002	48	0.040	2	C-2F	Clair	2000
B30048003	48	0.060	3	C-2F	Clair	2000
B30048005	48	0.105	5	C-2F	Clair	2000
B30060001	60	0.020	1.2	C-2F	Clair	2000
B30060003	60	0.050	3	C-2F	Clair	2000
B30060005	60	0.083	5	C-2F	Clair	2000
B30130002	130	0.020	2.6	C-3F	Clair	2000
B30130003	130	0.023	3	CC-3A	Clair	2000
B30130005	130	0.038	5	C-3F	Clair	2000
B30220003	220	0.014	3	C-7A	Clair	2000
B30220005	220	0.023	5	C-7A	Clair	2000
B30260005	260	0.019	5	C-7A	Clair	2000
B30260007	220-260		5-7	C-7A	Clair	2000

# Lampes Ba15d Tube T16X35mm



Numéro d'article	Voltage	Wattage	Filament	Teinte	Durée de vie (h)
B35006001	6	1.2	C-2R	Clair	2000
B35006002	6	2	C-2R	Clair	2000
B35006005	6	5	C-2V	Clair	2000
B35012001	12	1.5	C-2V	Clair	2000
B35012002	12	2	C-2R	Clair	2000
B35012003	12	3	C-2R	Clair	2000
B35012005	12	5	C-2V	Clair	2000
B35012010	12	10	C-2R	Clair	2000
B35024002	24	2	C-2F	Clair	2000
B35024003	24	3	C-2F	Clair	2000
B35024004	24	4	C-2V	Clair	2000
B35024005	24	5	C-2V	Clair	2000
B35024010	24	10	C-2F	Clair	2000
B350240104	24	10	C-2V	Clair	5000
B35030002	30	2	C-2F	Clair	2000
B35030003	30	3	C-2F	Clair	2000
B35030004	24-30	4	C-2F	Clair	2000
B35030005	30	5	C-2F	Clair	2000
B350300054	30	5	C-2V	Clair	5000
B35030007	24-30	5-7	C-2F	Clair	2000
B35030010	30	10	C-2F	Clair	2000
B35036003	36	3	C-2F	Clair	2000
B35036005	36	5	C-2F	Clair	2000
B35040003	40	3	C-3A	Clair	2000
B35042005	42	5	C-3A	Clair	2000
B35048003	48	3	C-3A	Clair	2000
B35048005	48	5	C-3A	Clair	2000
B35060002	60	2	C-3A	Clair	2000
B35060003	60	3	C-3A	Clair	2000
B35060005	60	5	C-3A	Clair	2000

# Lampes Ba15d Tube T16X35mm

Numéro d'article	Voltage	Wattage	Filament	Teinte	Durée de vie (h)
B35085004	85	4	C-3A	Clair	2000
B35085005	85	5	C-3A	Clair	2000
B35110003	110	3	C-5A	Clair	2000
B35110005	110	5	C-5A	Clair	2000
B35130005	130	5	C-5A	Clair	2000
B35140007	140	7	C-5A	Clair	2000
B35160005	160	5	C-5A	Clair	2000
B35220003	220	3	C-7A	Clair	2000
B35220005	220	5	C-7A	Clair	2000
B35255005	255	5	C-7A	Clair	2000
B35260005	220-260	3-5	C-7A	Clair	2000
B35260007	220-260	5-7	C-7A	Clair	2000
B35260010	220-260	6-10	C-7A	Clair	2000
B35300005	300	5	CC-7A	Clair	1000
B35300010	300	10	C-7A	Clair	1000

# Lampes Ba15d Tube T16X45mm



Numéro d'article	Voltage	Wattage	Filament	Teinte	Durée de vie (h)
B45006003	6	3	C-2R	Clair	2000
B45006004	6	4	C-2R	Clair	2000
B45006005	6	5	C-2R	Clair	2000
B45012004	12	4	C-2R	Clair	2000
B45012005	12	5	C-2V	Clair	2000
B45012010	12	10	C-2V	Clair	2000
B45012015	12	15	C-2V	Clair	2000
B450120152	12	15	C-2V	Clair	5000
B45024003	24	3	C-2V	Clair	2000
B45024004	24	4	C-2V	Clair	2000
B45024005	24	5	C-2V	Clair	2000
B45024006	24	6.5	C-2V	Clair	2000
B45024010	24	10	C-2V	Clair	2000
B45024015	24	15	C-2V	Clair	2000
B45030003	30	3	C-2V	Clair	2000
B45030005	30	5	C-2V	Clair	2000
B45030007	30	5-7	C-2F	Clair	2000
B45030010	24-30	6-10	C-2V	Clair	2000
B45036005	36	5	C-2F	Clair	2000
B45042005	42	5	C-2F	Clair	2000
B45048005	48	5	C-3A	Clair	2000
B45048010	48	10	C-3A	Clair	2000
B45060004	60	4	C-3A	Clair	2000
B45060005	60	5	C-3A	Clair	2000
B45060010	60	10	C-3A	Clair	2000
B45080006	80	6	C-3A	Clair	2000
B45110010	110	10	C-5A	Clair	2000
B45130005	130	5	C-5A	Clair	2000
B45130015	130	15	C-5A	Clair	2000
B45140007	110-140	5-7	C-5A	Clair	2000

# Lampes Ba15d Tube T16X45mm

Numéro d'article	Voltage	Wattage	Filament	Teinte	Durée de vie (h)
B45140010	110-140	6-10	C-5A	Clair	2000
B45150007	150	7	C-7A	Clair	2000
B45220010	220	10	C-7A	Clair	2000
B45240015	240	15	C-7A	Clair	2000
B45250015	250	15	C-7A	Clair	2000
B45260007	220-260	5-7	C-7A	Clair	2000
B45260010	220-260	6-10	C-7A	Clair	2000
B45260015	220-260	10-15	C-7A	Clair	2000
B45380010	380	10	C-7A	Clair	2000

# Lampes Ba15d

## Tube

### T16X54mm



Numéro d'article	Voltage	Wattage	Filament	Teinte	Durée de vie (h)
B54006003	6	3	C-2R	Clair	2000
B54006005	6	5	C-2R	Clair	2000
B54006010	6	10	C-2R	Clair	2000
B54006015	6	15	C-2R	Clair	2000
B54012004	12	4	C-2R	Clair	2000
B54012005	12	5	C-2R	Clair	2000
B54012010	12	10	C-2R	Clair	2000
B54012015	12	15	C-2V	Clair	2000
B54024002	24	2	C-2V	Clair	2000
B54024003	24	3	C-2V	Clair	2000
B54024004	24	4	C-2V	Clair	2000
B54024005	24	5	C-2V	Clair	2000
B54024007	24	7	C-2V	Clair	2000
B54024010	24	10	C-2V	Clair	2000
B54024015	24	15	C-2V	Clair	2000
B54024025	24	25	C-2V	Clair	2000
B54027005	24-30	3-5	C-2V	Clair	2000
B54027010	24-30	6-10	C-2V	Clair	2000
B54027015	24-30	10-15	C-2V	Clair	2000
B54030003	30	3	C-2V	Clair	2000
B54030005	30	5	C-2V	Clair	2000
B54030007	30	5-7	C-2V	Clair	2000
B54030010	30	10	C-2V	Clair	2000
B54030015	30	15	C-2F	Clair	2000
B54036005	36	5	C-2F	Clair	2000
B54040010	36-45	6-10	C-2F	Clair	2000
B54042003	42	3	C-2V	Clair	2000
B54042005	42	5	C-2F	Clair	2000
B54042010	42	10	C-2V	Clair	2000
B54042015	42	15	C-2F	Clair	2000

# Lampes Ba15d Tube T16X54mm

Numéro d'article	Voltage	Wattage	Filament	Teinte	Durée de vie (h)
B54048003	48	3	C-3A	Clair	2000
B54048005	48	5	C-3A	Clair	2000
B54048007	48	7	C-3A	Clair	2000
B54048010	48	10	C-3A	Clair	2000
B54048015	48	15	C-3A	Clair	2000
B54050010	48-60	6-10	C-3A	Clair	2000
B54060004	60	4	C-3A	Clair	2000
B54060005	60	5	C-3A	Clair	2000
B54060007	60	7	C-3A	Clair	2000
B54060010	60	10	C-3A	Clair	2000
B54080005	70-80	5	C-3A	Clair	2000
B54080007	80	7	C-3A	Clair	2000
B54095010	65-95	6-10	C-3A	Clair	2000
B54110005	110	5	C-5A	Clair	2000
B54130005	130	5	C-5A	Clair	2000
B54130010	130	10	C-5A	Clair	2000
B54140005	110-140	3-5	C-5A	Clair	2000
B54140007	110-140	5-7	C-5A	Clair	2000
B54140010	110-140	6-10	C-5A	Clair	2000
B54150005	150	5	C-5A	Clair	2000
B54160010	160	10	C-5A	Clair	2000
B54220005	220	5	C-7A	Clair	2000
B54220015	220	15	C-7A	Clair	2000
B54230015	230	15	C-7A	Clair	2000
B54240015	240	15	C-7A	Clair	2000
B54250015	250	15	C-7A	Clair	2000
B54260005	220-260	3-5	C-7A	Clair	2000
B54260006	220-260	4-6	C-7A	Clair	2000
B54260007	220-260	5-7	C-7A	Clair	2000
B54260010	220-260	6-10	C-7A	Clair	2000
B54260015	220-260	10-15	C-7A	Clair	2000
B54380010	380	10	CC-7A	Clair	2000

**Lampes Ba15d**  
**Poirette**  
**P22X48mm**

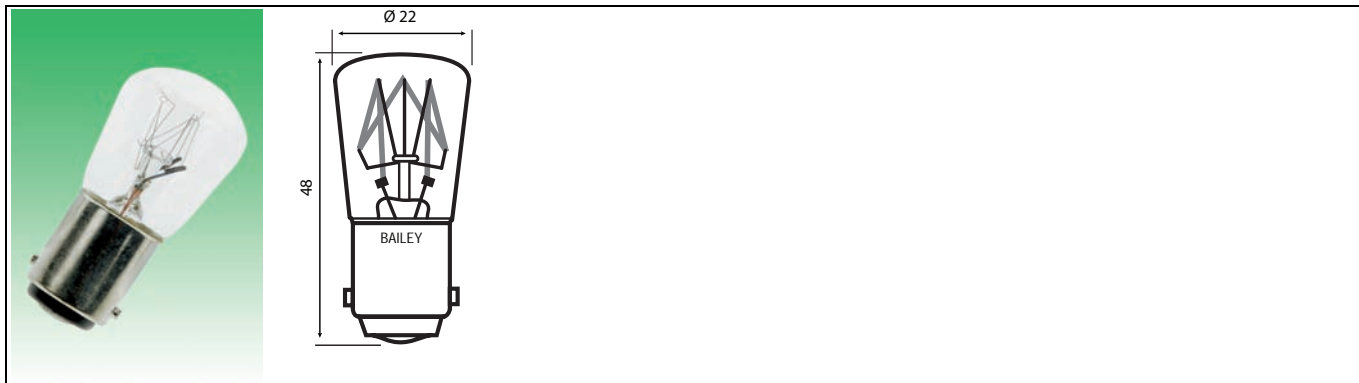

Numéro d'article	Voltage	Wattage	Filament	Teinte	Durée de vie (h)
B48006010	6	10	C-2R	Clair	1000
B48006015	6	15	C-2R	Clair	1000
B48012005	12	5	C-2R	Clair	1000
B48012010	12	10	C-2R	Clair	1000
B48012015	12	15	C-2R	Clair	1000
B48012025	12	25	C-2R	Clair	1000
B48024005	24	5	C-2V	Clair	1000
B48024007	24	7	C-2V	Clair	1000
B48024010	24	10	C-2V	Clair	1000
B48024015	24	15	C-2V	Clair	1000
B48024025	24	25	C-2V	Clair	1000
B48030010	30	10	C-2V	Clair	1000
B48042005	42	5	C-2V	Clair	1000
B48050010	50	10	C-3A	Clair	1000
B48075015	75	15	C-3A	Clair	1000
B48130005	130	5	C-5A	Clair	1000
B48130010	130	10	C-5A	Clair	1000
B48130015	130	15	C-5A	Clair	1000
B48240025	240	25	C-7A	Clair	1000
B48260007	220-260	5-7	C-7A	Clair	1000
B48260010	220-260	6-10	C-7A	Clair	1000
B48260015	220-260	10-15	C-7A	Clair	1000

# Lampes E12

## Tube

### T13X34mm

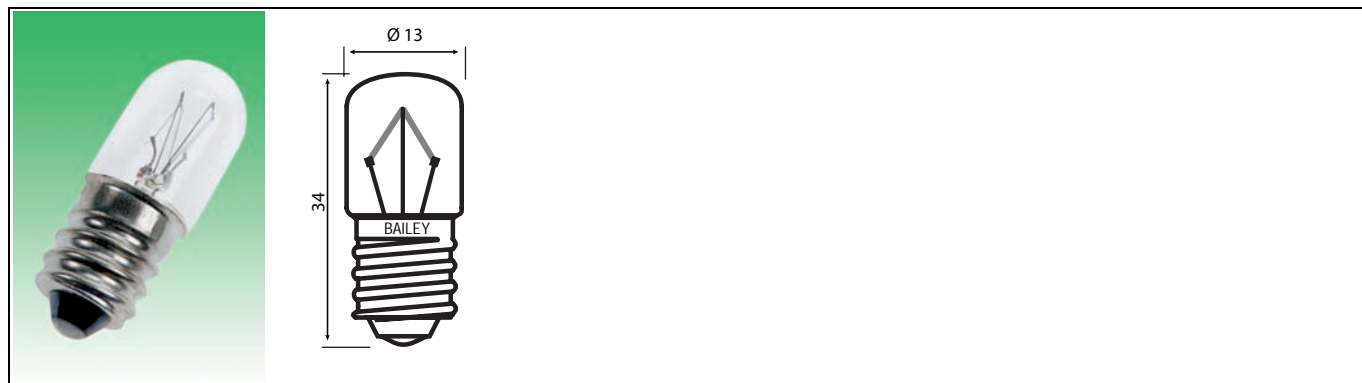

Numéro d'article	Voltage	Courant (A)	Wattage	Filament	Teinte	Durée de vie (h)
E34006001	6	0.333	1	C-2V	Clair	2000
E34012002	12	0.165	2	C-2V	Clair	2000
E34012003	12	0.250	3	C-2V	Clair	2000
E34012005	12	0.417	5	C-2V	Clair	2000
E34012010	12	0.833	10	C-2V	Clair	2000
E34018002	18	0.110	2	C-2V	Clair	2000
E34024002	24	0.080	2	C-2V	Clair	2000
E34024003	24	0.125	3	C-2V	Clair	2000
E34024005	24	0.208	5	C-2V	Clair	2000
E34028002	28	0.070	2	C-2V	Clair	2000
E34030005	30	0.017	5	C-2V	Clair	2000
E34030002	30	0.065	2	C-2F	Clair	2000
E34030003	30	0.100	3	C-2F	Clair	2000
E34042005	42	0.120	5	C-2F	Clair	2000
E34048002	48	0.040	2	C-2F	Clair	2000
E34048003	48	0.060	3	C-2F	Clair	2000
E34060002	60	0.033	2	C-2F	Clair	2000
E34060005	60	0.050	5	C-2F	Clair	2000
E34110003	110	0.027	3	CC-3	Clair	2000
E34110005	110	0.045	5	CC-3A	Clair	2000
E34130006	130	0.046	6	C-5A	Clair	2000
E34220005	220	0.023	5	CC-3A	Clair	2000

## Lampes E12

### Tube

T16X45mm



Numéro d'article	Voltage	Wattage	Filament	Teinte	Durée de vie (h)
E4406003	6	3	C-2R	Clair	2000
E44012003	12	3	C-2V	Clair	2000
E44024002	24	2	C-2V	Clair	2000
E44024003	24	3	C-2V	Clair	2000
E44024005	24	5	C-2V	Clair	2000
E44030005	30	5	C-2V	Clair	2000
E44048005	48	5	C-3A	Clair	2000
E44060005	60	5	C-3A	Clair	2000
E44130005	130	5	C-5A	Clair	2000
E44130006	130	6	C-5A	Clair	2000
E44140010	110-140	6-10	C-5A	Clair	2000
E44140015	140	15	C-5A	Clair	2000
E44220010	220	10	C-7A	Clair	2000
E44260007	220-260	5-7	C-7A	Clair	2000
E44260010	220-260	6-10	C-7A	Clair	2000

**Lampes E12  
Tube  
T16X54mm**



Numéro d'article	Voltage	Wattage	Filament	Teinte	Durée de vie (h)
E53024005	24	5	C-2V	Clair	2000
E53030010	24-30	6-10	C-2V	Clair	2000
E53060005	60	5	C-3A	Clair	2000
E53095010	65-95	6-10	C-3A	Clair	2000
E53130005	130	5	C-5A	Clair	2000
E53140007	140	7	C-5A	Clair	2000
E53140010	110-140	6-10	C-5A	Clair	2000
E53230015	230	15	C-7A	Clair	2000
E53260007	220-260	5-7	C-7A	Clair	2000
E53260010	220-260	6-10	C-7A	Clair	2000
E53260015	220-260	10-15	C-7A	Clair	2000

**Lampes E12  
S6 Type US  
19X48mm**

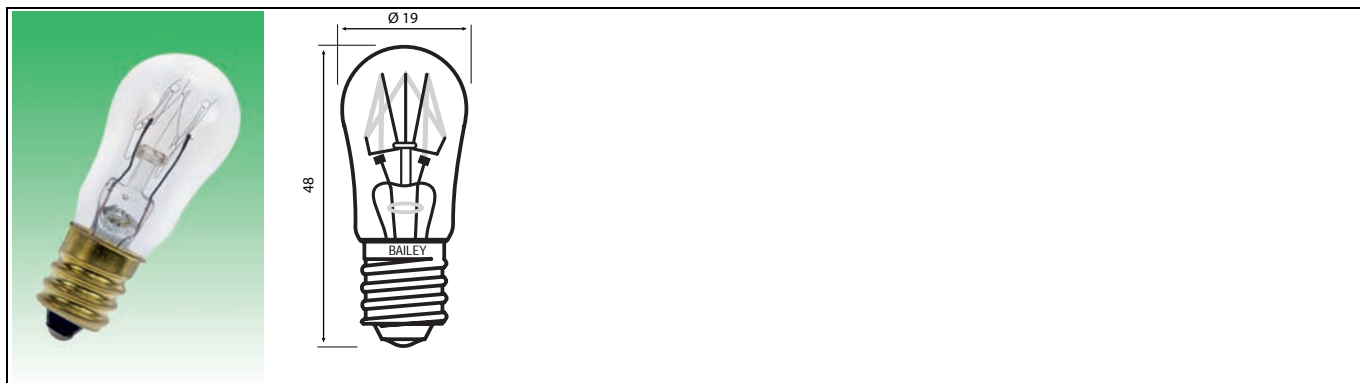

Numéro d'article	Voltage	Wattage	Filament	Teinte	V (h)	Forme
E47006006	6	6	C-2R	Clair	1500	6S6
E47012006	12	6	C-2V	Clair	1500	6S6
E47024005	24	5	C-2V	Clair	1500	5S6
E47024006	24	6	C-2V	Clair	1500	6S6
E47030006	30	6	C-2V	Clair	1500	6S6
E47032006	32	6	C-2V	Clair	1500	6S6
E47048006	48	6	C-5A	Clair	1500	6S6
E47060006	60	6	C-5A	Clair	1500	6S6
E47075006	75	6	C-5A	Clair	1500	6S6
E47110015	110	15	C-3A	Clair	1500	15S6
E47120006	120	6	C-5A	Clair	1500	6S6
E47130003	130	3	C-5A	Clair	1500	3S6
E47130004	130	4	C-5A	Clair	1500	4S6
E47250007	250	7	C-5A	Clair	1500	7S6
E47250010	250	10	C-5A	Clair	1500	10S6
E47250015	250	15	C-5A	Clair	1500	15S6

# Lampes E14 Tube T13X30mm

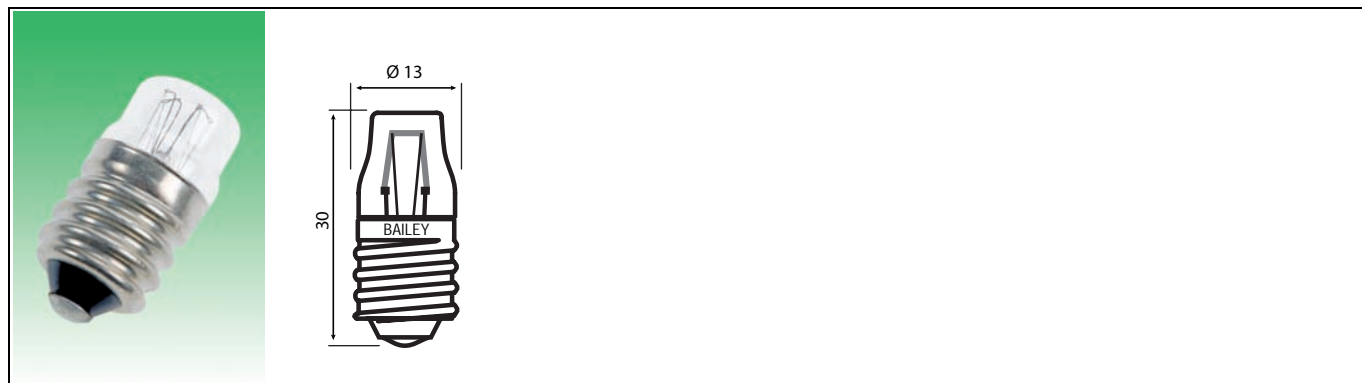

Numéro d'article	Voltage	Courant (A)	Wattage	Filament	Teinte	V (h)
E30004250	4	0.250	1	C-2R	Clair	2000
E30004750	4	0.750	3	C-2V	Clair	2000
E30006180	6	0.180	1.1	C-2V	Clair	2000
E30006333	6	0.333	2	C-2R	Clair	2000
E30006500	6	0.500	3	C-2R	Clair	2000
E30006850	6	0.850	5	C-2R	Clair	2000
E30012100	12	0.100	1.2	C-2V	Clair	2000
E30012120	12	0.120	1.45	C-2V	Clair	2000
E30012165	12	0.165	2	C-2V	Clair	2000
E30012250	12	0.250	3	C-2V	Clair	2000
E30012410	12	0.410	5	C-2V	Clair	2000
E30024040	24	0.040	1	C-2F	Clair	2000
E30024050	24	0.050	1.2	C-2F	Clair	2000
E30024080	24	0.080	2	C-2F	Clair	2000
E30024125	24	0.125	3	C-2F	Clair	2000
E30024210	24	0.210	5	C-2F	Clair	2000
E30030002	24-30		2	C-2F	Clair	2000
E30030050	30	0.050	1.5	C-2F	Clair	2000
E30030065	30	0.065	2	C-2F	Clair	2000
E30030080	30	0.080	2.4	C-2F	Clair	2000
E30030100	30	0.100	3	C-2F	Clair	2000
E30030167	30	0.167	5	C-2F	Clair	2000
E30036050	36	0.050	1.8	C-2F	Clair	2000
E30036055	36	0.055	2	C-2F	Clair	2000
E30036080	36	0.080	3	C-2F	Clair	2000
E30036140	36	0.140	5	C-2F	Clair	2000
E30042050	42	0.050	2.1	C-2F	Clair	2000
E30042070	42	0.070	3	C-2F	Clair	2000
E30042120	42	0.120	5	C-2F	Clair	2000
E30045002	36-45		2	C-2F	Clair	2000

# Lampes E14

## Tube

### T13X30mm

Numéro d'article	Voltage	Courant (A)	Wattage	Filament	Teinte	V (h)
E30048040	48	0.040	2	C-2F	Clair	2000
E30048060	48	0.060	3	C-2F	Clair	2000
E30048105	48	0.105	5	C-2F	Clair	2000
E30060002	48-60		2	C-2F	Clair	2000
E30060020	60	0.020	1.2	C-2F	Clair	2000
E30060033	60	0.033	2	C-2F	Clair	2000
E30060040	60	0.040	2.4	C-2F	Clair	2000
E30060050	60	0.050	3	C-2F	Clair	2000
E30060085	60	0.085	5	C-2F	Clair	2000
E30070002	60-70		2	C-2F	Clair	2000
E30080035	80	0.035	3	C-3A	Clair	2000
E30080063	80	0.063	5	C-3A	Clair	2000
E30110045	110	0.045	5	C-5A	Clair	2000
E30130020	130	0.020	2.6	CC-3A	Clair	2000
E30130040	130	0.040	5	C-5A	Clair	2000
E30220014	230	0.014	3	C-7A	Clair	2000
E30220023	220	0.023	5	C-7A	Clair	2000
E30230013	230	0.013	3	C-7A	Clair	2000
E30260019	260	0.019	5	C-7A	Clair	2000
E30260027	220-260	0.027	5-7	C-7A	Clair	2000

# Lampes E14 Tube T16X35mm



Numéro d'article	Voltage	Wattage	Filament	Teinte	Durée de vie (h)
E35006001	6	1	C-2R	Clair	2000
E35006002	6	2	C-2R	Clair	2000
E35006005	6	5	C-2R	Clair	2000
E35008003	8	3	C-2R	Clair	2000
E35012002	12	2	C-2V	Clair	2000
E35012003	12	3	C-2R	Clair	2000
E35012005	12	5	C-2V	Clair	2000
E35024002	24	2	C-2V	Clair	2000
E35024003	24	3	C-2V	Clair	2000
E35024004	24	4	C-2V	Clair	2000
E35024005	24	5	C-2V	Clair	2000
E35030003	30	3	C-2V	Clair	2000
E35030005	30	5	C-2V	Clair	2000
E35036003	36	3	C-2F	Clair	2000
E35036005	36	5	C-2F	Clair	2000
E35042005	42	5	C-2F	Clair	2000
E35048003	48	3	C-3A	Clair	2000
E35048005	48	5	C-3A	Clair	2000
E35060001	60	1	C-3A	Clair	2000
E35060002	60	2	C-3A	Clair	2000
E35060003	60	3	C-3A	Clair	2000
E35060005	60	5	C-3A	Clair	2000
E35080005	80	5	C-3A	Clair	2000
E35110005	110	5	C-5A	Clair	2000
E35130002	130	2.6	C-5A	Clair	2000
E35130005	130	5	C-5A	Clair	2000
E35130015	130	15	C-5A	Clair	2000
E35140007	110-140	5-7	C-5A	Clair	2000
E35150005	150	5	C-5A	Clair	2000
E35160005	160	5	C-5A	Clair	2000

**Lampes E14****Tube****T16X35mm**

Numéro d'article	Voltage	Wattage	Filament	Teinte	Durée de vie (h)
E35230003	230	3	C-7A	Clair	2000
E35260003	220-260	3	C-7A	Clair	2000
E35260005	220-260	3-5	C-7A	Clair	2000
E35260007	220-260	5-7	C-7A	Clair	2000
E35260010	220-260	6-10	C-7A	Clair	2000

# Lampes E14 Tube T16X45mm

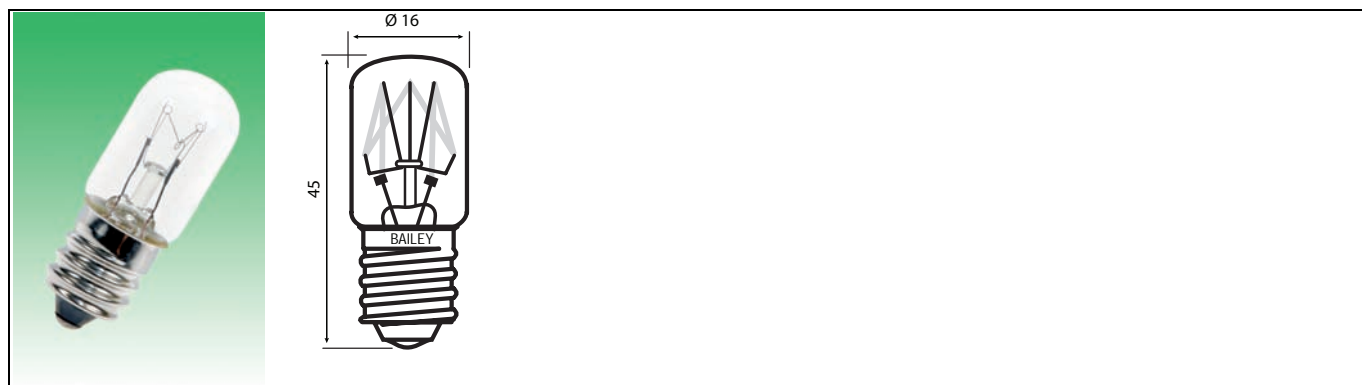

Numéro d'article	Voltage	Wattage	Filament	Teinte	Durée de vie (h)
E45006001	6	1	C-2R	Clair	2000
E45006005	6	5	C-2R	Clair	2000
E45012003	12	3	C-2R	Clair	2000
E45012005	12	5	C-2R	Clair	2000
E45012010	12	10	C-2V	Clair	2000
E45014005	14	5	C-2V	Clair	2000
E45024002	24	2	C-2V	Clair	2000
E45024003	24	3	C-2V	Clair	2000
E45024005	24	5	C-2V	Clair	2000
E45024007	24	7	C-2V	Clair	2000
E45024010	24	10	C-2V	Clair	2000
E45024015	24	15	C-2V	Clair	2000
E45030003	30	3	C-2V	Clair	2000
E45030005	30	5	C-2V	Clair	2000
E45030007	30	5-7	C-2V	Clair	2000
E45030010	24-30	6-10	C-2V	Clair	2000
E45036005	36	5	C-2V	Clair	2000
E45042005	42	5	C-2F	Clair	2000
E45048005	48	5	C-3A	Clair	2000
E45048010	48	10	C-3A	Clair	2000
E45060005	60	5	C-3A	Clair	2000
E45060007	60	7	C-3A	Clair	2000
E45060010	60	10	C-3A	Clair	2000
E45130005	130	5	C-5A	Clair	2000
E45140007	110-140	5-7	C-5A	Clair	2000
E45140010	110-140	6-10	C-5A	Clair	2000
E45160005	160	5	C-5A	Clair	2000
E45220010	220	10	C-7A	Clair	2000
E45260005	220-260	3-5	C-7A	Clair	2000
E45260007	220-260	5-7	C-7A	Clair	2000

**Lampes E14****Tube****T16X45mm**

Numéro d'article	Voltage	Wattage	Filament	Teinte	Durée de vie (h)
E45260010	220-260	6-10	C-7A	Clair	2000
E45260015	220-260	10-15	C-7A	Clair	2000
E45380010	380	10	C-7A	Clair	2000

# Lampes E14 Tube T16X54mm



Numéro d'article	Voltage	Wattage	Filament	Teinte	Durée de vie (h)
E54004005	4	5	C-2R	Clair	2000
E54006001	6	1	C-2R	Clair	2000
E54006003	6	3	C-2R	Clair	2000
E54006004	6	4	C-2R	Clair	2000
E54006005	6	5	C-2R	Clair	2000
E54006010	6	10	C-2R	Clair	2000
E54006015	6	15	C-2R	Clair	2000
E54008003	8	3	C-2R	Clair	2000
E54012002	12	2	C-2V	Clair	2000
E54012003	12	3	C-2R	Clair	2000
E54012004	12	4	C-2R	Clair	2000
E54012005	12	5	C-2R	Clair	2000
E54012007	12	7	C-2R	Clair	2000
E54012010	12	10	C-2R	Clair	2000
E54012015	12	15	C-2V	Clair	2000
E54014005	14	5	C-2V	Clair	2000
E54024002	24	2	C-2V	Clair	2000
E54024003	24	3	C-2V	Clair	2000
E54024004	24	4	C-2V	Clair	2000
E54024005	24	5	C-2V	Clair	2000
E54024007	24	7	C-2V	Clair	2000
E54024010	24	10	C-2V	Clair	2000
E54024015	24	15	C-2V	Clair	2000
E54024025	24	25	C-2V	Clair	1000
E54030002	30	2	C-2V	Clair	2000
E54030003	30	3	C-3A	Clair	2000
E54030004	30	4	C-2V	Clair	2000
E54030005	30	5	C-2V	Clair	2000
E54030007	30	7	C-2V	Clair	2000
E54030009	24-30	3-5	C-2V	Clair	2000

# Lampes E14

## Tube

### T16X54mm

Numéro d'article	Voltage	Wattage	Filament	Teinte	Durée de vie (h)
E54030010	24-30	6-10	C-2V	Clair	2000
E54030011	30	10	C-2V	Clair	2000
E54030015	30	15	C-3A	Clair	2000
E54030016	24-30	10-15	C-2V	Clair	2000
E54032005	32-42	5-7	C-2F	Clair	2000
E54036005	36	5	C-2F	Clair	2000
E54042003	42	3	C-3A	Clair	2000
E54042005	42	5	C-3A	Clair	2000
E54042007	42	7	C-3A	Clair	2000
E54042010	42	10	C-2F	Clair	2000
E54042015	42	15	C-3A	Clair	2000
E54045005	45-60	5-7	C-3A	Clair	2000
E54045010	36-45	6-10	C-2F	Clair	2000
E54048003	48	3	C-3A	Clair	2000
E54048005	48	5	C-3A	Clair	2000
E54048010	48	10	C-3A	Clair	2000
E54048010F	48	10	C-3A	Dépolie	2000
E54048015	48	15	C-3A	Clair	2000
E54060003	60	3	C-3A	Clair	2000
E540600035	60	3.5	C-3A	Clair	2000
E54060004	60	4	C-3A	Clair	2000
E54060005	60	5	C-3A	Clair	2000
E54060007	60	7	C-3A	Clair	2000
E54060010	60	10	C-3A	Clair	3000
E54060011	48-60	6-10	C-3A	Clair	2000
E54060015	60	15	C-3A	Clair	2000
E54065005	65	5	C-3A	Clair	2000
E54065007	65	7	C-3A	Clair	2000
E54065010	65	10	C-3A	Clair	2000
E54065015	65	15	C-3A	Clair	2000
E54070004	60-70	4	C-3A	Clair	2000
E54070005	70	5	C-3A	Clair	2000
E54072015	72	15	C-3A	Clair	2000
E54080005	80	5	C-3A	Clair	2000
E54080007	80	7	C-3A	Clair	2000
E54080010	70-80	10	C-3A	Clair	2000
E54080015	80	15	C-3A	Clair	2000
E54095010	65-95	6-10	C-3A	Clair	2000
E54110010	110	10	C-5A	Clair	2000
E54110015	110	15	C-5A	Clair	2000

# Lampes E14

## Tube

### T16X54mm

Numéro d'article	Voltage	Wattage	Filament	Teinte	Durée de vie (h)
E54130005	130	5	C-5A	Clair	2000
E54130015	130	15	C-5A	Clair	2000
E54140007	110-140	5-7	C-5A	Clair	2000
E54140010	110-140	6-10	C-5A	Clair	2000
E54150005	150	5	C-5A	Clair	2000
E54160007	160	7	C-5A	Clair	2000
E54220005	220	5	C-7A	Clair	2000
E54220010	220	10	C-7A	Clair	2000
E54220015	220	15	C-7A	Clair	2000
E54240015	240	15	C-7A	Clair	2000
E54260003	220-260	3	C-7A	Clair	2000
E54260005	220-260	3-5	C-7A	Clair	2000
E54260006	220-260	4-6	C-7A	Clair	2000
E54260007	220-260	5-7	C-7A	Clair	2000
E54260010	220-260	6-10	C-7A	Clair	2000
E542600105	220-260	6-10	CC-7A	Clair	20000
E54260015	220-260	10-15	C-7A	Clair	2000
E54380010	380	10	CC-7A	Clair	2000

# Lampes E14

## Poirette

### P22X48mm

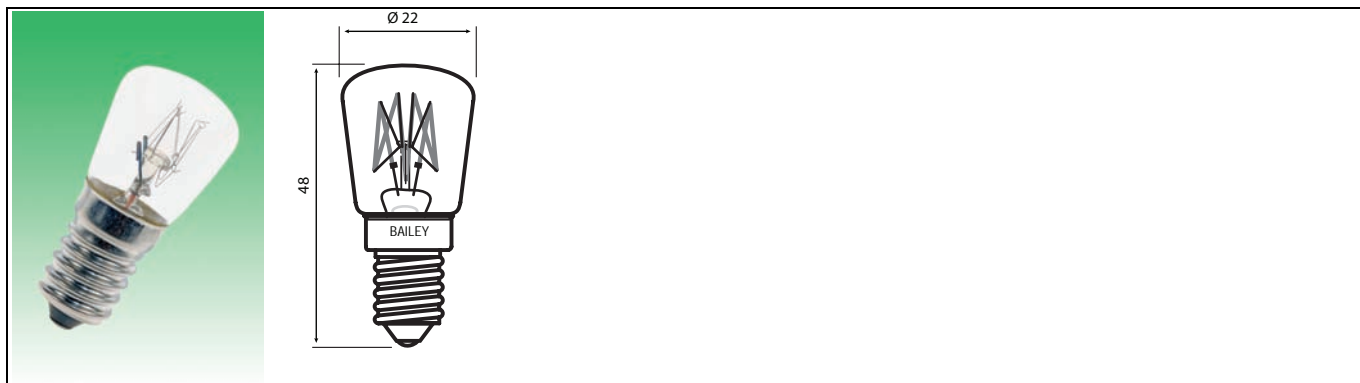

Numéro d'article	Voltage	Wattage	Filament	Teinte	Durée de vie (h)
E48012005	12	5	C-2R	Clair	1000
E48012010	12	10	C-2R	Clair	1000
E48012015	12	15	C-2R	Clair	1000
E48012025	12	25	C-2V	Clair	1000
E48024003	24	3	C-2V	Clair	1000
E48024005	24	5	C-2V	Clair	1000
E48024010	24	10	C-2V	Clair	1000
E48024015	24	15	C-2V	Clair	1000
E48024025	24	25	C-2V	Clair	1000
E48024040	24	40	C-2V	Clair	1000
E48030005	30	5	C-3A	Clair	1000
E48042005	42	5	C-3A	Clair	1000
E48048015	42-48	15	C-3A	Clair	1000
E48060007	60	7	C-3A	Clair	1000
E48060010	60	10	C-3A	Clair	1000
E48060015	60	15	C-3A	Clair	1000
E48065015	65	15	C-3A	Clair	1000
E48080007	80	7	C-3A	Clair	1000
E48130005	130	5	C-5A	Clair	1000
E48130010	130	10	C-5A	Clair	1000
E48130015	130	15	C-5A	Clair	1000
E48220010*	220	10	C-7A	Clair	1000
E48235015*	235	15	C-7A	Clair	1000
E48235025*	235	25	C-7A	Clair	1000
E48260007	220-260	5-7	C-7A	Clair	1000
E48260010	220-260	6-10	C-7A	Clair	1000
E48260015	220-260	10-15	C-7A	Clair	1000

\* 300° Celsius

# Lampes Navettes

## S6

6X24mm

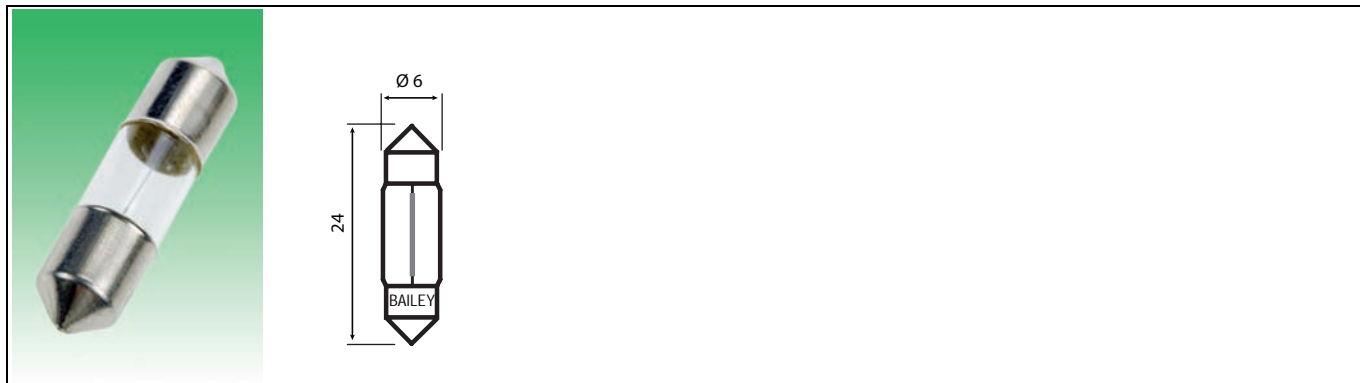

Numéro d'article	Voltage	Courant (A)	Wattage	Filament	Teinte	V (h)
S62406050	6	0.050	0.3	C-6	Clair	2000
S62406100	6	0.100	0.6	C-6	Clair	2000
S62406165	6	0.165	1	C-6	Clair	2000
S62406500	6	0.500	3	C-6	Clair	2000
S62408220	8	0.220	1.8	C-6	Clair	2000
S62412050	12	0.050	0.6	C-6	Clair	2000
S62412100	12	0.100	1.2	C-6	Clair	2000
S62412165	12	0.165	2	C-6	Clair	2000
S62412250	12	0.250	3	C-6	Clair	2000
S62424050	24	0.050	1.2	C-6	Clair	2000
S62424125	24	0.125	3	C-6	Clair	2000
S62426040	26	0.040	1	C-6	Clair	2000
S62428070	28	0.070	2	C-6	Clair	2000
S62428107	28	0.107	3	C-6	Clair	2000

## Lampes Navettes

**S6**

**6X28mm**



Numéro d'article	Voltage	Courant (A)	Wattage	Filament	Teinte	V (h)
S62806200	6	0.200	1.2	C-8	Clair	2000
S62806500	6	0.500	3	C-6	Clair	2000
S62812100	12	0.100	1.2	C-6	Clair	2000
S62812250	12	0.250	3	C-6	Clair	2000
S62824050	24	0.050	1.2	C-6	Clair	2000
S62824125	24	0.125	3	C-6	Clair	2000
S62826110	26	0.110	3	C-6	Clair	2000
S62848050	48	0.050	2.4	C-6	Clair	2000
S62850050	50	0.050	2.5	C-6	Clair	1000
S62860050	60	0.050	3	C-6	Clair	2000

# Lampes Navettes

## S6

6X31mm



Numéro d'article	Voltage	Courant (A)	Wattage	Filament	Teinte	V (h)
S63106040	6	0.040	0.24	C-6	Clair	2000
S63106050	6	0.050	0.3	C-6	Clair	2000
S63106100	6	0.100	0.6	C-6	Clair	2000
S63106500	6	0.500	3	C-6	Clair	2000
S63106150	6.3	0.150	1	C-6	Clair	2000
S63106250	6.3	0.250	1.6	C-6	Clair	2000
S63106300	6.3	0.300	1.89	C-6	Clair	2000
S63108150	8	0.150	1.2	C-6	Clair	2000
S63108250	8	0.250	2	C-6	Clair	2000
S63108300	8	0.300	2.4	C-6	Clair	2000
S63112100	12	0.100	1.2	C-6	Clair	2000
S63112150	12	0.150	1.8	C-6	Clair	2000
S63112165	12	0.165	2	C-6	Clair	2000
S63112250	12	0.250	3	C-6	Clair	2000
S63112300	12	0.300	3.6	C-6	Clair	2000
S63113300	12.6	0.300	3.8	C-6	Clair	2000
S63118100	18	0.100	1.8	C-6	Clair	2000
S63118167	18	0.167	3	C-6	Clair	2000
S63124050	24	0.050	1.2	C-6	Clair	2000
S63124062	24	0.062	1.5	C-6	Clair	2000
S63124080	24	0.080	2	C-6	Clair	2000
S63124125	24	0.125	3	C-6	Clair	2000
S63126040	26	0.040	1	C-6	Clair	2000
S63128070	28	0.070	2	C-6	Clair	2000
S63130050	30	0.050	1.5	C-6	Clair	2000
S63130100	30	0.100	3	C-6	Clair	2000
S63148062	48	0.062	3	C-6	Clair	2000
S63165046	65	0.046	3	C-6	Clair	2000

# Lampes Navettes

## S6

6X36mm



Numéro d'article	Voltage	Courant (A)	Wattage	Filament	Teinte	V (h)
S63604001	4.8	0.300	1.44	C-6	Clair	2000
S63606003	6	0.500	3	C-6	Clair	2000
S63612001	12	0.100	1.2	C-6	Clair	2000
S63612003	12	0.250	3	C-6	Clair	2000
S63615001	15	0.080	1.2	C-6	Clair	2000
S636180012	18	0.067	1.2	C-6	Clair	2000
S63618003	18	0.167	3	C-8	Clair	2000
S63624001	24	0.050	1.2	C-6	Clair	2000
S63624002	24	0.080	2	C-6	Clair	2000
S63624003	24	0.125	3	C-6	Clair	2000
S63626001	26	0.040	1	C-6	Clair	2000
S63628002	28	0.070	2	C-6	Clair	2000
S63628003	28	0.107	3	C-6	Clair	2000
S63630003	30	0.100	3	C-6	Clair	2000
S63636003	36	0.083	3	C-6	Clair	2000
S63648003	48	0.060	3	CC-6	Clair	2000
S63660003	60	0.050	3	C-6	Clair	2000

# Lampes Navettes

## S6

6X39mm



Numéro d'article	Voltage	Courant (A)	Wattage	Filament	Teinte	V (h)
S63906003	6	0.500	3	C-6	Clair	2000
S63912001	12	0.100	1.2	C-6	Clair	2000
S63912003	12	0.250	3	C-6	Clair	2000
S639150012	15	0.080	1.2	C-6	Clair	2000
S63917002	17	0.118	2	C-6	Clair	2000
S63918003	18	0.167	3	C-6	Clair	2000
S63924001	24	0.050	1.2	C-6	Clair	2000
S63924002	24	0.080	2	C-6	Clair	2000
S63924003	24	0.125	3	C-6	Clair	2000
S63928002	28	0.070	2	C-6	Clair	2000
S63928003	28	0.107	3	C-6	Clair	2000
S63930003	30	0.100	3	C-6	Clair	2000
S63932003	32	0.094	3	C-6	Clair	2000
S63936003	36	0.083	3	C-6	Clair	2000
S63948003	48	0.060	3	C-6	Clair	2000
S63960003	60	0.050	3	C-6	Clair	2000

## Lampes Navettes

**S7**

**8X28mm**

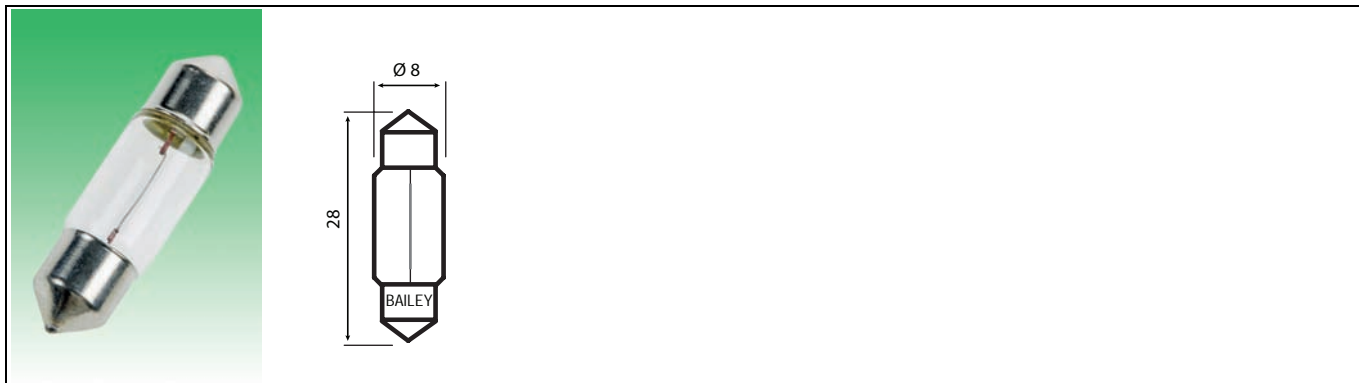

Numéro d'article	Voltage	Courant (A)	Wattage	Filament	Teinte	V (h)
S72812003	12	0.250	3	C-6	Clair	2000
S72812005	12	0.417	5	C-6	Clair	2000
S72824002	24	0.080	2	C-6	Clair	2000
S72824003	24	0.125	3	C-6	Clair	2000
S72824005	24	0.210	5	C-6	Clair	2000
S72830002	30	0.065	2	C-6	Clair	2000
S72832003	32	0.094	3	C-6	Clair	2000

# Lampes Navettes

## S7

8X31mm



Numéro d'article	Voltage	Courant (A)	Wattage	Filament	Teinte	V (h)
S73106003	6	0.500	3	C-6	Clair	2000
S73106005	6	0.830	5	C-6	Clair	2000
S73107100	7	0.100	0.7	C-6	Clair	2000
S73112001	12	0.083	1	C-6	Clair	2000
S73112002	12	0.165	2	C-6	Clair	2000
S73112003	12	0.250	3	C-6	Clair	2000
S73112005	12	0.417	5	C-6	Clair	2000
S73115001	15	0.080	1.2	C-6	Clair	2000
S73115003	15	0.200	3	C-6	Clair	2000
S73118003	18	0.167	3	C-6	Clair	2000
S731240012	24	0.050	1.2	C-6	Clair	2000
S731240015	24	0.063	1.5	C-6	Clair	2000
S73124002	24	0.080	2	C-6	Clair	2000
S73124003	24	0.125	3	C-6	Clair	2000
S73124005	24	0.210	5	C-6	Clair	2000
S73128005	28	0.180	5	C-6	Clair	2000
S73130003	30	0.100	3	C-6	Clair	2000
S73130005	30	0.167	5	C-6	Clair	2000
S73132003	32	0.095	3	C-6	Clair	2000
S73136003	36	0.083	3	C-6	Clair	2000
S73148003	48	0.065	3	C-6	Clair	2000
S73148005	48	0.105	5	C-6	Clair	2000
S73160001	60	0.020	1.2	C-6	Clair	2000
S73160003	60	0.050	3	C-6	Clair	2000
S73160005	60	0.083	5	C-6	Clair	2000

## Lampes Navettes

**S7**

**8X36mm**



Numéro d'article	Voltage	Courant (A)	Wattage	Filament	Teinte	V (h)
S73606003	6	0.500	3	C-6	Clair	2000
S73606005	6	0.833	5	C-6	Clair	2000
S73612003	12	0.250	3	C-6	Clair	2000
S73612005	12	0.417	5	C-6	Clair	2000
S73624002	24	0.080	2	C-6	Clair	2000
S73624003	24	0.125	3	C-6	Clair	2000
S73624005	24	0.210	5	C-6	Clair	2000
S73628003	28	0.107	3	C-6	Clair	2000
S73630003	30	0.100	3	C-6	Clair	2000
S73630005	30	0.167	5	C-6	Clair	2000
S73648003	48	0.060	3	C-6	Clair	2000
S73648005	48	0.104	5	C-6	Clair	2000
S73660003	60	0.050	3	C-6	Clair	2000

# Lampes Navettes

## S7

8X39mm



Numéro d'article	Voltage	Courant (A)	Wattage	Filament	Teinte	V (h)
S73906003	6	0.500	3	C-6	Clair	2000
S73906005	6	0.833	5	C-6	Clair	2000
S739120012	12	0.100	1.2	C-6	Clair	2000
S73912003	12	0.250	3	C-6	Clair	2000
S73912005	12	0.417	5	C-6	Clair	2000
S73916003	16	0.188	3	C-6	Clair	2000
S739240012	24	0.050	1.2	C-6	Clair	2000
S73924003	24	0.125	3	C-6	Clair	2000
S73924005	24	0.210	5	C-6	Clair	2000
S73930003	30	0.100	3	C-6	Clair	2000
S73930005	30	0.167	5	C-6	Clair	2000
S73948005	48	0.105	5	C-6	Clair	2000

## Lampes Navettes

**S8.5**

11X30mm

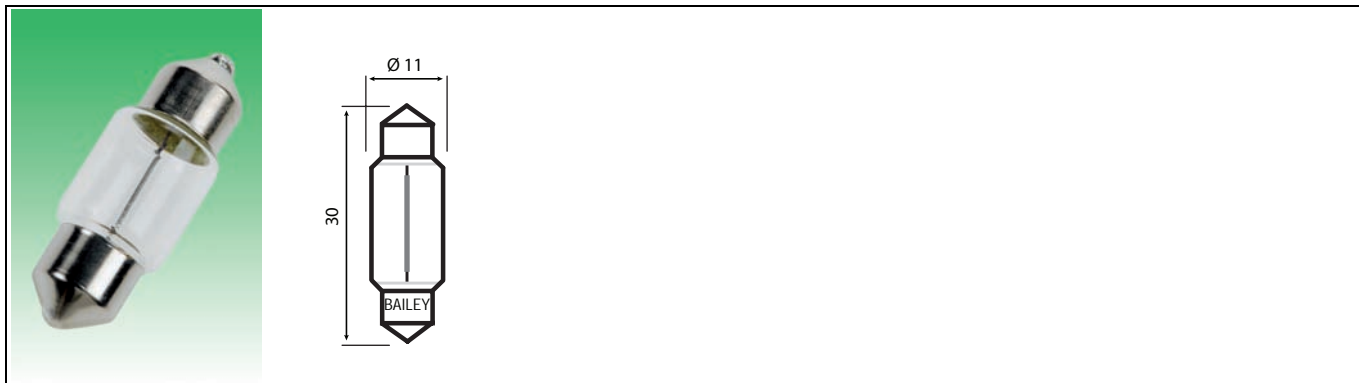

Numéro d'article	Voltage	Courant (A)	Wattage	Filament	Teinte	V (h)
S83006005	6	0.833	5	C-6	Clair	2000
S83006010	6	1.667	10	C-6	Clair	2000
S83012005	12	0.417	5	C-6	Clair	2000
S83012010	12	0.833	10	C-6	Clair	2000
S83024005	24	0.208	5	C-6	Clair	2000
S83024010	24	0.417	10	C-6	Clair	2000

# Lampes Navettes

## S8.5

11X36mm



Numéro d'article	Voltage	Courant (A)	Wattage	Filament	Teinte	V (h)
S83606005	6	0.833	5	C-6	Clair	2000
S83606010	6	1.667	10	C-6	Clair	2000
S83612003	12	0.250	3	C-6	Clair	2000
S83612005	12	0.417	5	C-6	Clair	2000
S83612010	12	0.833	10	C-6	Clair	2000
S83624003	24	0.125	3	C-6	Clair	2000
S83624005	24	0.208	5	C-6	Clair	2000
S83624010	24	0.417	10	C-6	Clair	2000

# Lampes Navettes

## S8.5

11X39mm



Numéro d'article	Voltage	Courant (A)	Wattage	Filament	Teinte	V (h)
S83906000	6	0.050	0.3	C-6	Clair	2000
S83906003	6	0.500	3	C-6	Clair	2000
S83906005	6	0.833	5	C-6	Clair	2000
S83912000	12	0.050	0.6	C-6	Clair	2000
S83912001	12	0.100	1.2	C-6	Clair	2000
S83912003	12	0.250	3	C-6	Clair	2000
S83912005	12	0.417	5	C-6	Clair	2000
S83912010	12	0.833	10	C-6	Clair	2000
S83918005	18	0.278	5	C-6	Clair	2000
S83924001	24	0.050	1.2	C-6	Clair	2000
S83924002	24	0.080	2	C-6	Clair	2000
S83924003	24	0.125	3	C-6	Clair	2000
S83924003G	24	0.125	3	C-6	Vert	2000
S83924003R	24	0.125	3	C-6	Rouge	2000
S83924005	24	0.208	5	C-6	Clair	2000
S83924005G	24	0.208	5	C-6	Vert	2000
S83924005R	24	0.208	5	C-6	Rouge	2000
S83924010	24	0.417	10	C-6	Clair	2000
S83930002	30	0.065	2	C-6	Clair	2000
S83930003	30	0.100	3	C-6	Clair	2000
S83930005	30	0.167	5	C-6	Clair	2000
S83936003	36	0.083	3	C-6	Clair	2000
S83936005	36	0.140	5	C-6	Clair	2000
S83948003	48	0.063	3	C-6	Clair	2000
S83948005	48	0.105	5	C-6	Clair	2000
S83960003	60	0.050	3	C-6	Clair	2000
S83960005	60	0.083	5	C-6	Clair	2000

# Lampes Navettes

## S8.5

11X42mm



Numéro d'article	Voltage	Courant (A)	Wattage	Filament	Teinte	V (h)
S84212005	12	0.417	5	C-6	Clair	2000
S84224005	24	0.208	5	C-6	Clair	2000
S84224010	24	0.417	10	C-6	Clair	2000
S84242005	42	0.120	5	C-6	Clair	2000
S84248005	48	0.104	5	C-6	Clair	2000

## Lampes Navettes

### S8.5

11X44mm



Numéro d'article	Voltage	Courant (A)	Wattage	Filament	Teinte	V (h)
S84406003	6	0.500	3	C-6	Clair	2000
S84406005	6	0.833	5	C-6	Clair	2000
S84406010	6	1.667	10	C-6	Clair	2000
S84412003	12	0.125	3	C-6	Clair	2000
S84412005	12	0.417	5	C-6	Clair	2000
S84412010	12	0.833	10	C-6	Clair	2000
S84412010F	12	0.833	10	C-6	Dépolie	2000
S84412015	12	1.250	15	C-6	Clair	2000
S84415005	15	0.333	5	C-6	Clair	2000
S84418005	18	0.278	5	C-6	Clair	2000
S84424001	24	0.050	1.2	C-6	Clair	2000
S84424002	24	0.080	2	C-6	Clair	2000
S84424003	24	0.125	3	C-6	Clair	2000
S84424003A	24	0.125	3	C-6	Orange	2000
S84424003G	24	0.125	3	C-6	Vert	2000
S84424003R	24	0.125	3	C-6	Rouge	2000
S84424004	24	0.167	4	C-6	Clair	2000
S84424005	24	0.208	5	C-8	Clair	2000
S84424005G	24	0.208	5	C-8	Vert	2000
S84424005R	24	0.208	5	C-6	Rouge	2000
S84424010	24	0.417	10	C-6	Clair	2000
S84424020	24	0.830	20	C-6	Clair	2000
S84430003	30	0.100	3	C-6	Clair	2000
S84430005	30	0.167	5	C-6	Clair	2000
S84430010	30	0.333	10	C-6	Clair	2000
S84442005	42	0.120	5	C-6	Clair	2000
S84448003	48	0.063	3	C-6	Clair	2000
S84448005	48	0.104	5	CC-6	Clair	2000
S84460003	60	0.050	3	C-6	Clair	2000
S84460005	60	0.083	5	C-6	Clair	2000

# Lampes Navettes

## S8.5

15X44mm

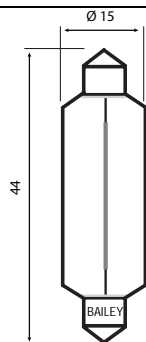

Numéro d'article	Voltage	Courant (A)	Wattage	Filament	Teinte	V (h)
S84506005	6	0.833	5	C-6	Clair	2000
S84506010	6	1.667	10	C-6	Clair	2000
S84506015	6	2.500	15	C-6	Clair	2000
S84506018	6	3.000	18	C-6	Clair	100
S84512003	12	0.250	3	C-6	Clair	2000
S84512005	12	0.417	5	C-6	Clair	2000
S84512010	12	0.833	10	C-6	Clair	2000
S84512015	12	1.250	15	C-6	Clair	2000
S84512018	12	1.500	18	C-6	Clair	2000
S84512021	12	1.750	21	C-6	Clair	2000
S84524003	24	0.125	3	C-6	Clair	2000
S84524005	24	0.208	5	C-6	Clair	2000
S84524010	24	0.417	10	C-6	Clair	2000
S84524015	24	0.625	15	C-6	Clair	2000
S84524018	24	0.750	18	C-6	Clair	2000
S84528010	28	0.357	10	C-6	Clair	2000
S84530005	30	0.167	5	C-6	Clair	2000
S84530010	30	0.333	10	C-6	Clair	2000
S84536005	36	0.140	5	C-6	Clair	2000
S84548005	48	0.104	5	C-6	Clair	2000
S84548010	48	0.208	10	C-6	Clair	2000
S84560003	60	0.050	3	C-6	Clair	2000
S84560005	60	0.083	5	C-6	Clair	2000
S84560010	60	0.167	10	C-6	Clair	2000
S84580005	80	0.063	5	C-6	Clair	2000
S84580010	80	0.125	10	C-6	Clair	2000

# Lampes Navettes

## S8.5 Xénon

10X44mm

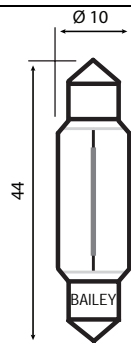

Avantages produit:

- Longue durée de vie
- Pas d'émission de rayons UV
- Moins de chaleur
- Variable/Graduable

Numéro d'article	Voltage	Courant (A)	Wattage	Filament	Teinte	V (h)
SX84412003	12	0.250	3	C-8	Clair	10000
SX84412003F	12	0.250	3	C-8	Dépolie	10000
SX84412005	12	0.417	5	C-8	Clair	10000
SX84412005F	12	0.417	5	C-8	Dépolie	10000
SX84412006	12	0.500	6	C-8	Clair	10000
SX84412006F	12	0.500	6	C-8	Dépolie	10000
SX84412010	12	0.833	10	CC-8	Clair	5000
SX84412010F	12	0.833	10	C-8	Dépolie	10000
SX844220072	22	0.327	7.2	C-6	Clair	10000
SX84424003	24	0.125	3	CC-8	Clair	6000
SX84424003F	24	0.125	3	CC-8	Dépolie	6000
SX84424005	24	0.208	5	CC-8	Clair	10000
SX84424005F	24	0.208	5	CC-8	Dépolie	10000
SX84424006	24	0.250	6	C-8	Clair	10000
SX84424006F	24	0.250	6	CC-8	Dépolie	5000
SX84424010	24	0.417	10	CC-8	Clair	7500
SX84424010F	24	0.417	10	CC-8	Dépolie	7500

# Lampes Navettes

## SF6

### Embouts plats

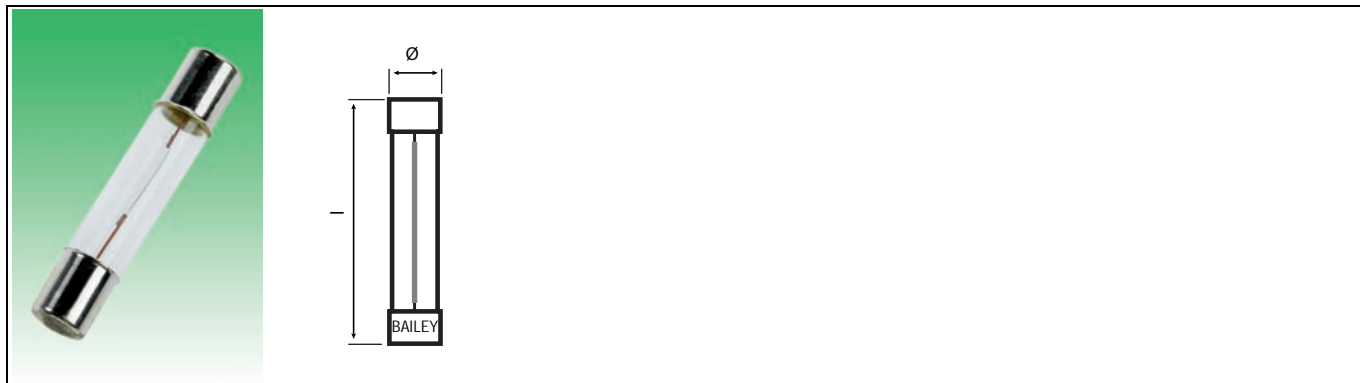

Numéro d'article	Voltage	Courant (A)	Wattage	Filament	Teinte	V (h)	ø (mm)	l (mm)
SF2612100	12	0.100	1.2	C-6	Clair	3000	6.3	26
SF3106100	6	0.100	0.6	C-6	Clair	3000	6	31
SF3106150	6	0.150	0.9	C-6	Clair	3000	6	31
SF3106101	6.3	0.100	0.63	C-6	Clair	3000	6	31
SF3106151	6.3	0.150	0.95	C-8	Clair	3000	6	31
SF3106250	6.3	0.250	1.58	C-6	Clair	3000	6	31
SF3106300	6.3	0.300	1.89	C-6	Clair	3000	6	31
SF3108100	8	0.100	0.8	C-6	Clair	3000	6	31
SF3108150	8	0.150	1.2	C-6	Clair	3000	6	31
SF3108250	8	0.250	2	C-6	Clair	3000	6	31
SF3108300	8	0.300	2.4	C-6	Clair	3000	6	31
SF3112100	12	0.100	1.2	C-6	Clair	3000	6	31
SF3112150	12	0.150	1.8	C-6	Clair	3000	6	31
SF3112300	12	0.300	3.6	C-6	Clair	3000	6	31
SF3112151	12.6	0.150	1.89	C-6	Clair	3000	6	31
SF3112251	12.6	0.250	3.15	C-6	Clair	3000	6	31
SF3624125	24	0.125	3	C-6	Clair	3000	6	36

# Lampe navette à boucle Xénon 10X44mm

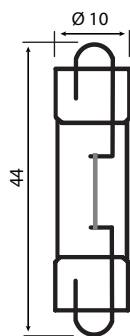

Avantages produit:

- Longue durée de vie
- Homogénéité de la lumière
- Lumière plus intense que l'incandescence
- Pas d'émission de rayons UV
- Moins de chaleur
- Variable/Graduable

Numéro d'article	Voltage	Courant (A)	Wattage	Filament	Teinte	V (h)
SXRL4412005	12	0.417	5	C-8	Clair	20000
SXRL4412005F	12	0.417	5	C-8	Dépolie	20000
SXRL44120085	12	0.708	8.5	C-8	Clair	20000
SXRL44120085F	12	0.708	8.5	C-8	Dépolie	20000
SXRL4412010	12	0.833	10	C-8	Clair	20000
SXRL4412010F	12	0.833	10	C-8	Dépolie	20000
SXRL4424005	24	0.208	5	CC-8	Clair	20000
SXRL4424005F	24	0.208	5	CC-8	Dépolie	20000
SXRL44240085	24	0.354	8.5	CC-8	Clair	10000
SXRL44240085F	24	0.354	8.5	CC-8	Dépolie	10000
SXRL4424010	24	0.417	10	CC-8	Clair	20000
SXRL4424010F	24	0.417	10	CC-8	Dépolie	20000
SXRL44260051F	26	0.192	5	CC-8	Dépolie	3000
SXRL44260085	26	0.327	8.5	CC-8	Clair	20000
SXRL44260085F	26	0.327	8.5	CC-8	Dépolie	20000

# Lampes Néon Midget Flanged

T1 - T1 3/4

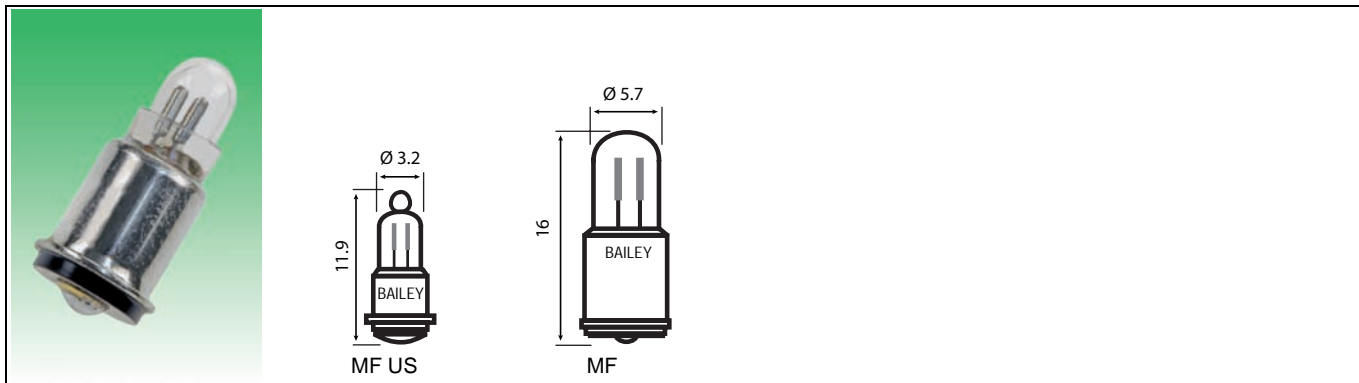

Numéro d'article	Voltage	Culot	Matière	Teinte	ø (mm)	l (mm)
NF10065GC	65-95	MF US	Verre	Clair	3.2	11.9
NF16065GC	65	MF	Verre	Clair	5.7	16
NF16110GC	110	MF	Verre	Clair	5.7	16
NF16110GG	110	MF	Verre	Vert	5.7	16
NF16220GC	220	MF	Verre	Clair	5.7	16
NF16220GG	220	MF	Verre	Vert	5.7	16

# Lampes Néon Midget Grooved

T1 3/4

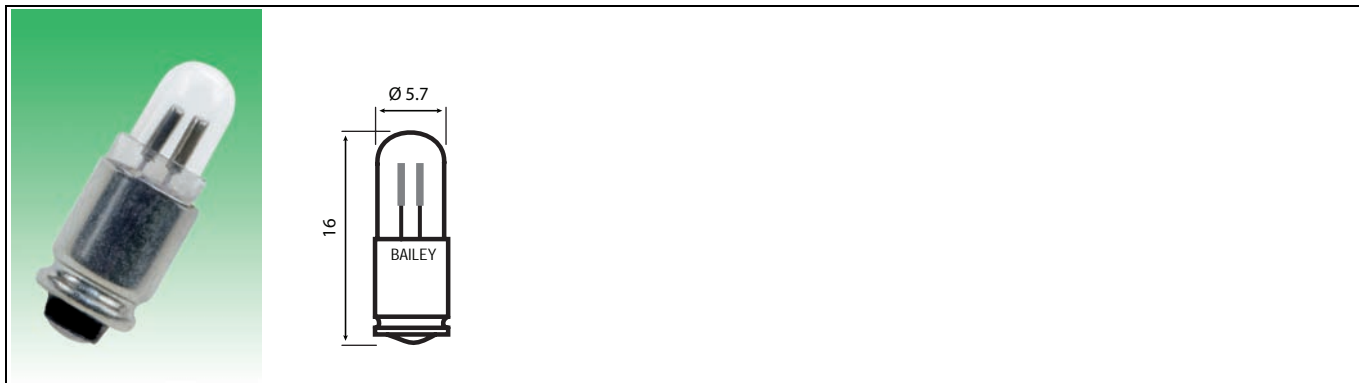

Numéro d'article	Voltage	Culot	Matière	Teinte	ø (mm)	l (mm)
NG16065GC	65	MG	Verre	Clair	5.7	16
NG16110GC	110	MG	Verre	Clair	5.7	16
NG16110GG	110	MG	Verre	Vert	5.7	16
NG16220GC	220	MG	Verre	Clair	5.7	16
NG16220GG	220	MG	Verre	Vert	5.7	16

# Lampes Néon

## Ba7s

T7X20mm - T7X23mm



Numéro d'article	Voltage	Culot	Matière	Teinte	ø (mm)	l (mm)
NB20110GC	110	Ba7s	Verre	Clair	7	20
NB20220GC	220	Ba7s	Verre	Clair	7	20
NB22085GC	85	Ba7s	Verre	Clair	7	23
NB22110GC	110	Ba7s	Verre	Clair	7	23
NB22220GC	220	Ba7s	Verre	Clair	7	23

# Lampes Néon Lampes Téléphoniques

T4.5 - T4.6 - T5.5K - T5.5 - T6.5F - T6.8G

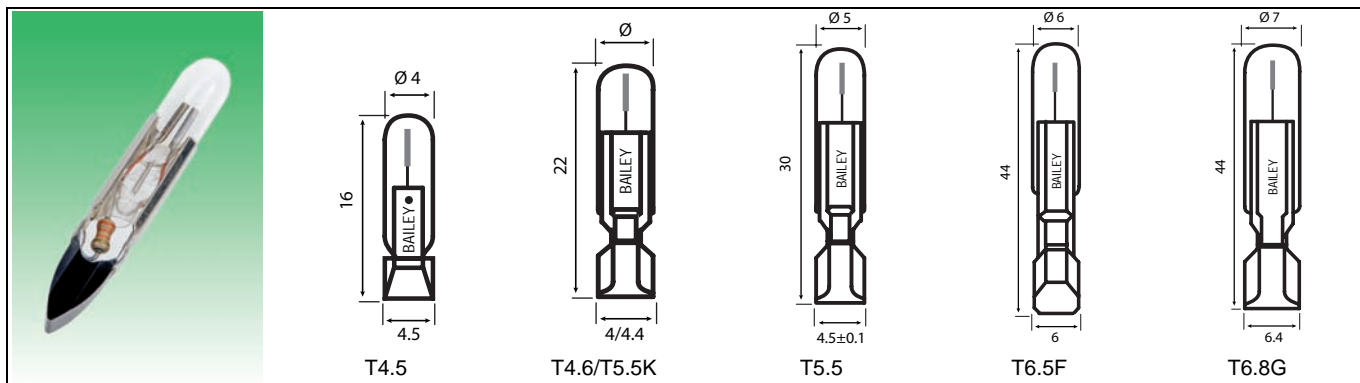

Numéro d'article	Voltage	Culot	Matière	Teinte	$\varnothing$ (mm)	l (mm)
NT16110GC	110	T4.5	Verre	Clair	4	16
NT16220GC	220	T4.5	Verre	Clair	4	17
NT21065GC	65	T4.6	Verre	Clair	4	22
NT21110GC	110	T4.6	Verre	Clair	4	22
NT21220GC	220	T4.6	Verre	Clair	4	22
NT22065GC	65	T5.5K	Verre	Clair	5	22
NT22110GC	110	T5.5K	Verre	Clair	5	22
NT22220GC	220	T5.5K	Verre	Clair	5	22
NT30065GC	65	T5.5	Verre	Clair	5	30
NT30110GC	110	T5.5	Verre	Clair	5	30
NT30220GC	220	T5.5	Verre	Clair	5	30
NT30220GG	220	T5.5	Verre	Vert	5	30
NT43220GC	220	T6.5F	Verre	Clair	6	44
NT44110GC	110	T6.8G	Verre	Clair	7	44
NT44110GG	110	T6.8G	Verre	Vert	7	44
NT44220GC	220	T6.8G	Verre	Clair	7	44
NT44220GG	220	T6.8G	Verre	Vert	7	44

# Lampes Néon

## Ba9s

T9X25mm - T10X28mm

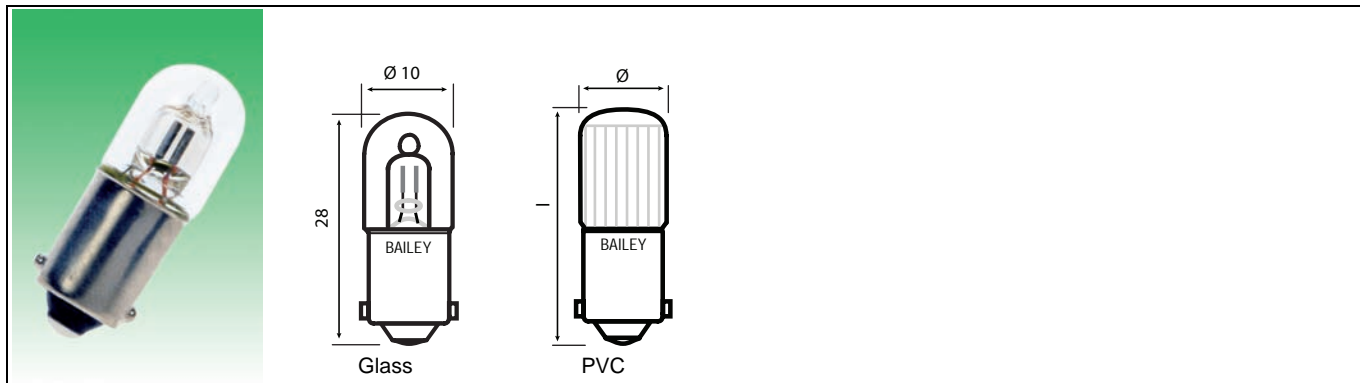

Numéro d'article	Voltage	Culot	Matière	Teinte	ø (mm)	l (mm)
NB23110GC	110-130	Ba9s	Verre	Clair	9	25
NB23110GG	110-130	Ba9s	Verre	Vert	9	25
NB23110PC	110-130	Ba9s	PVC	Clair	9	25
NB23110PG	110-130	Ba9s	PVC	Vert	9	25
NB23220GC	220-240	Ba9s	Verre	Clair	9	25
NB23220GG	220-240	Ba9s	Verre	Vert	9	25
NB23220PC	220-240	Ba9s	PVC	Clair	9	25
NB23220PG	220-240	Ba9s	PVC	Vert	9	25
NB23380GC	380-400	Ba9s	Verre	Clair	9	25
NB23380GG	380-400	Ba9s	Verre	Vert	9	25
NB23380PC	380-400	Ba9s	PVC	Clair	9	25
NB23380PG	380-400	Ba9s	PVC	Vert	9	25
NB28065PC	65	Ba9s	PVC	Clair	10	28
NB28110GC	110-130	Ba9s	Verre	Clair	10	28
NB28110GG	110-130	Ba9s	Verre	Vert	10	28
NB28110PC	110-130	Ba9s	PVC	Clair	10	28
NB28110PG	110-130	Ba9s	PVC	Vert	10	28
NB28220GC	220-240	Ba9s	Verre	Clair	10	28
NB28220GG	220-240	Ba9s	Verre	Vert	10	28
NB28220PC	220-240	Ba9s	PVC	Clair	10	28
NB28220PG	220-240	Ba9s	PVC	Vert	10	28
NB28380GC	380-400	Ba9s	Verre	Clair	10	28
NB28380GG	380-400	Ba9s	Verre	Vert	10	28
NB28380PC	380-400	Ba9s	PVC	Clair	10	28
NB28380PG	380-400	Ba9s	PVC	Vert	10	28

# Lampes Néon

## E10

T9X25mm - T10X28mm

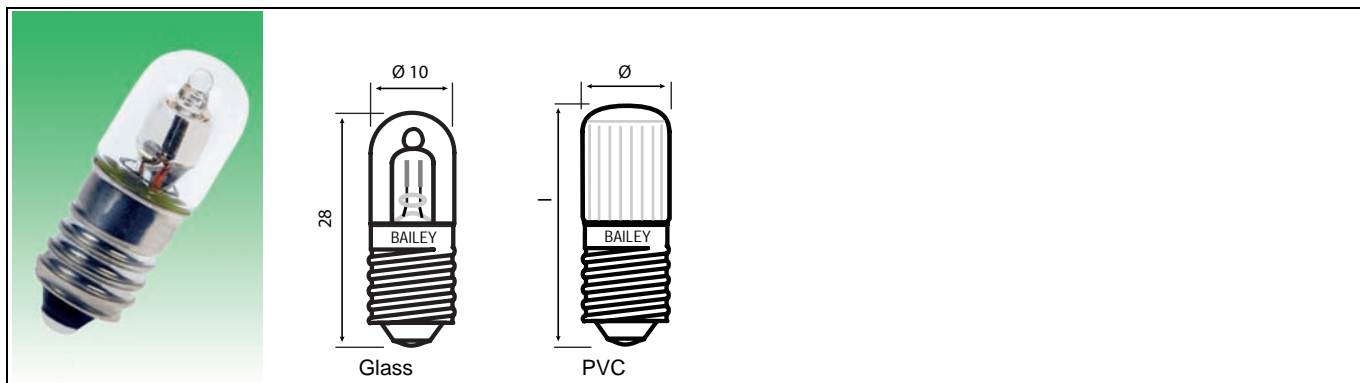

Numéro d'article	Voltage	Culot	Matière	Teinte	ø (mm)	l (mm)
NE23110GC	110-130	E10	Verre	Clair	9	25
NE23110GG	110-130	E10	Verre	Vert	9	25
NE23110PC	110-130	E10	PVC	Clair	9	25
NE23220GC	220-240	E10	Verre	Clair	9	25
NE23220GG	220-240	E10	Verre	Vert	9	25
NE23220PC	220-240	E10	PVC	Clair	9	25
NE23220PG	220-240	E10	PVC	Vert	9	25
NE23380GC	380-400	E10	Verre	Clair	9	25
NE23380PC	380-400	E10	PVC	Clair	9	25
NE28110GC	110-130	E10	Verre	Clair	10	28
NE28110GG	110-130	E10	Verre	Vert	10	28
NE28110PC	110-130	E10	PVC	Clair	10	28
NE28110PG	110-130	E10	PVC	Vert	10	28
NE28220GC	220-240	E10	Verre	Clair	10	28
NE28220GG	220-240	E10	Verre	Vert	10	28
NE28220PC	220-240	E10	PVC	Clair	10	28
NE28220PG	220-240	E10	PVC	Vert	10	28
NE28380GC	380-400	E10	Verre	Clair	10	28
NE28380GG	380-400	E10	Verre	Vert	10	28
NE28380PC	380-400	E10	PVC	Clair	10	28
NE28380PG	380-400	E10	PVC	Vert	10	28

# Lampes Néon Ba15d - Ba15s

T14X30mm - T16X35mm - T16X54mm

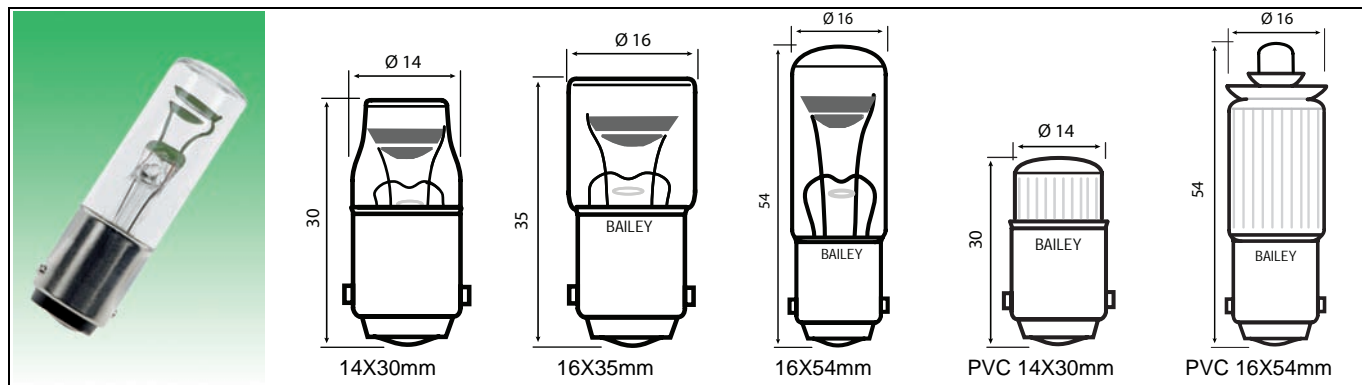

Numéro d'article	Voltage	Culot	Matière	Teinte	ø (mm)	l (mm)
NB30065PC	65	Ba15d	PVC	Clair	14	30
NB30110GC	110-130	Ba15d	Verre	Clair	14	30
NB30110GG	110-130	Ba15d	Verre	Vert	14	30
NB30110PC	110-130	Ba15d	PVC	Clair	14	30
NB30110PG	110-130	Ba15d	PVC	Vert	14	30
NB30220GC	220-240	Ba15d	Verre	Clair	14	30
NB30220GG	220-240	Ba15d	Verre	Vert	14	30
NB30220PC	220-240	Ba15d	PVC	Clair	14	30
NB30220PG	220-240	Ba15d	PVC	Vert	14	30
NB30380GC	380-400	Ba15d	Verre	Clair	14	30
NB30380PC	380-400	Ba15d	PVC	Clair	14	30
NB30380PG	380-400	Ba15d	PVC	Vert	14	30
NB35110GC	110-130	Ba15d	Verre	Clair	16	35
NB35220GC	220-240	Ba15d	Verre	Clair	16	35
NB35380GC	380-400	Ba15d	Verre	Clair	16	35
NB54110GC	110-130	Ba15d	Verre	Clair	16	54
NB54110PC	110-130	Ba15d	PVC	Clair	16	54
NB54220GC	220-240	Ba15d	Verre	Clair	16	54
NB54220PC	220-240	Ba15d	PVC	Clair	16	54
NB54380GC	380-400	Ba15d	Verre	Clair	16	54
NB54380PC	380-400	Ba15d	PVC	Clair	16	54
NS54220GC	220-240	Ba15s	Verre	Clair	16	54

## Lampes Néon

**E12**

**T15X38mm**

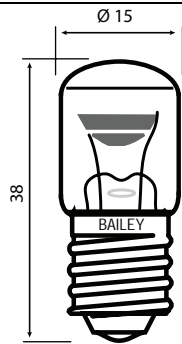

Numéro d'article	Voltage	Culot	Matière	Teinte	ø (mm)	l (mm)
NE38110GC	110-130	E12	Verre	Clair	15	38
NE38220GC	220-240	E12	Verre	Clair	13	34

# Lampes Néon

## E14

T14X30mm - T16X35mm - T16X54mm

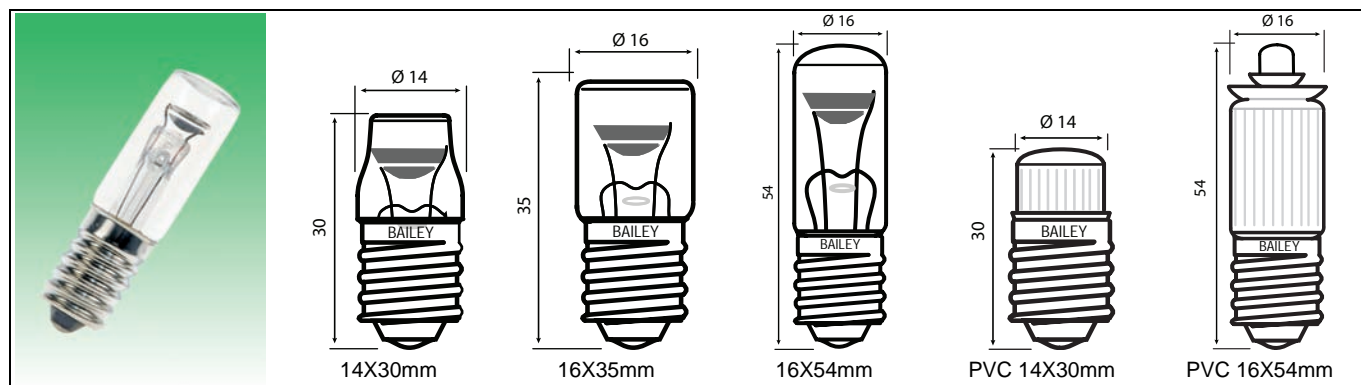

Numéro d'article	Voltage	Culot	Matière	Teinte	ø (mm)	l (mm)
NE30110GC	110-130	E14	Verre	Clair	14	30
NE30110GG	110-130	E14	Verre	Vert	14	30
NE30110PC	110-130	E14	PVC	Clair	14	30
NE30110PG	110-130	E14	PVC	Vert	14	30
NE30220GC	220-240	E14	Verre	Clair	14	30
NE30220GG	220-240	E14	Verre	Vert	14	30
NE30220PC	220-240	E14	PVC	Clair	14	30
NE30220PG	220-240	E14	PVC	Vert	14	30
NE30380GC	380-400	E14	Verre	Clair	14	30
NE30380GG	380-400	E14	Verre	Vert	14	30
NE30380PC	380-400	E14	PVC	Clair	14	30
NE30380PG	380-400	E14	PVC	Vert	14	30
NE35110GC	110-130	E14	Verre	Clair	16	35
NE35220GC	220-240	E14	Verre	Clair	16	35
NE35380GC	380-400	E14	Verre	Clair	16	35
NE54110GC	110-130	E14	Verre	Clair	16	54
NE54110PC	110-130	E14	PVC	Clair	16	54
NE54110PG	110-130	E14	PVC	Vert	16	54
NE54220GC	220-240	E14	Verre	Clair	16	54
NE54220PC	220-240	E14	PVC	Clair	16	54
NE54220PG	220-240	E14	PVC	Vert	16	54
NE54380GC	380-400	E14	Verre	Clair	16	54
NE54380PC	380-400	E14	PVC	Clair	16	54

# Lampes Néon

## B22d - E27

T27X60mm

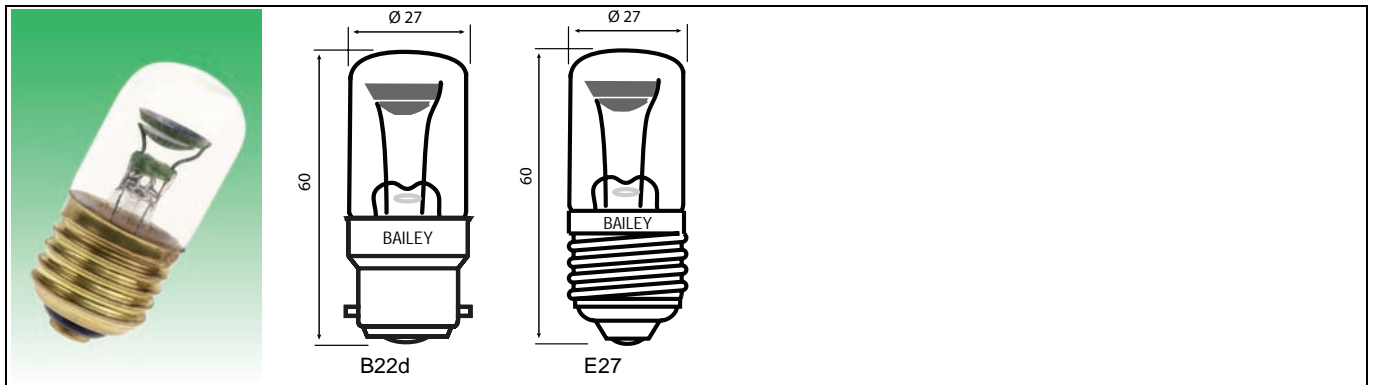

Numéro d'article	Voltage	Culot	Matière	Teinte	ø (mm)	l (mm)
NB60110GC	110-130	B22d	Verre	Clair	27	60
NB60220GC	220-240	B22d	Verre	Clair	27	60
NE60220GC	240	E27	Verre	Clair	27	60

# Accessoires

## Tire-lampes

### 3.17 - 15mm

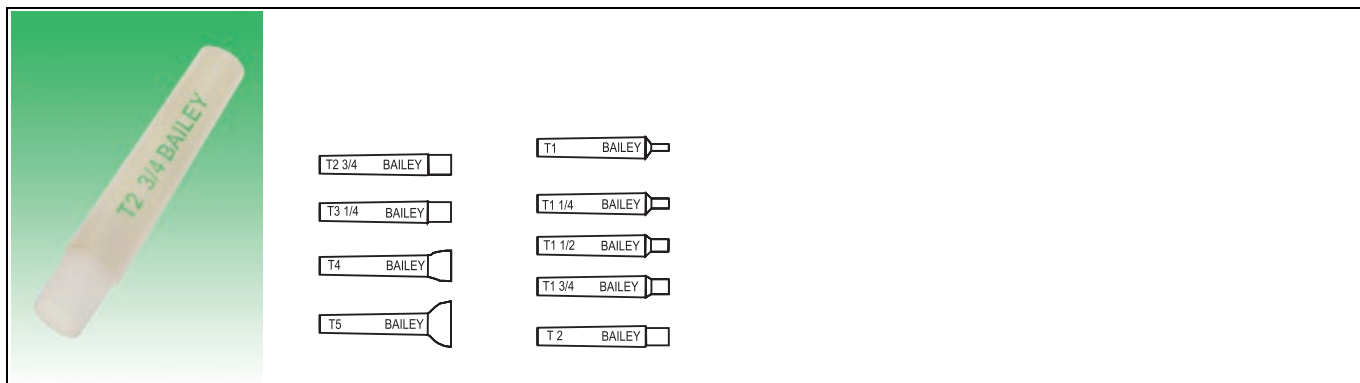

Numéro d'article	∅ (mm)	l (mm)	Application
LAMPEXSET			Kit des 9 tire-lampes
LAMPEXT1	3.17	59	T1 WE - Bi-Pin - MF
LAMPEXT114	4.12	59	T1 1/4 WE - Bi-Pin - MF - T4.5 - T4.6 - T5.5 EUBA
LAMPEXT112	5.1	59	T1 1/2 MT - Wedge T5 - T5.5K - T5.5 - T6.0 Skandia
LAMPEXT134	5.7	59	T1 3/4 Bi-Pin - MG - MF - MS - Ba5s - T6.5F - ESB - PSB - BPO
LAMPEXT2	6.6	59	T2 Ba7s - T6.8G - F9 - T9
LAMPEXT234	8.5	59	T2 3/4 Ba9s - E10
LAMPEXT314	10	59	T3 1/4 Ba9s - E10 - E12 - Wedge T10
LAMPEXT4	13	59	T4 Ba15d - E12 - E14
LAMPEXT5	15	59	T5 Wedge T15 - Ba15d - E12 - E14

## Accessoires





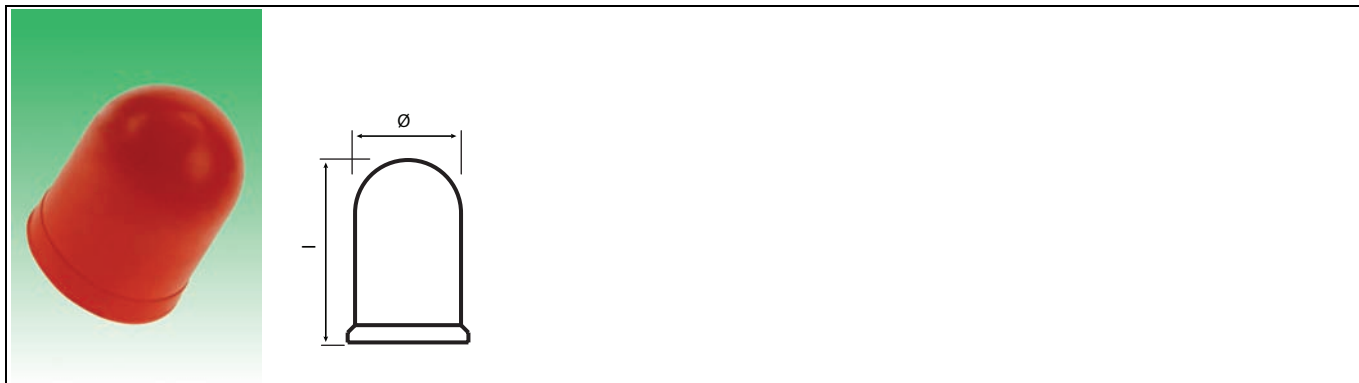



### Capuchons silicone

3.6 - 10.5mm



Numéro d'article	ø (mm)	l (mm)	Couleur	Forme	
ZSILICT1A	3.6	6.7	Orange	T1	
ZSILICT1B	3.6	6.7	Bleu	T1	
ZSILICT1G	3.6	6.7	Vert	T1	
ZSILICT1R	3.6	6.7	Rouge	T1	
ZSILICT1Y	3.6	6.7	Jaune	T1	
ZSILICT114A	4.8	7.4	Orange	T1 1/4	
ZSILICT114B	4.8	7.4	Bleu	T1 1/4	
ZSILICT114G	4.8	7.4	Vert	T1 1/4	
ZSILICT114R	4.8	7.4	Rouge	T1 1/4	
ZSILICT114Y	4.8	7.4	Jaune	T1 1/4	
ZSILICT134A	6	12	Orange	T1 3/4	
ZSILICT134B	6	12	Bleu	T1 3/4	
ZSILICT134G	6	12	Vert	T1 3/4	
ZSILICT134R	6	12	Rouge	T1 3/4	
ZSILICT134Y	6	12	Jaune	T1 3/4	
ZSILICT314A	10.5	13	Orange	T3 1/4	
ZSILICT314B	10.5	13	Bleu	T3 1/4	
ZSILICT314G	10.5	13	Vert	T3 1/4	
ZSILICT314R	10.5	13	Rouge	T3 1/4	
ZSILICT314Y	10.5	13	Jaune	T3 1/4	

**Filaments  
Total**

 <p>C-2R</p>	 <p>C-2V</p>	 <p>C-2F/CC-2F</p>	 <p>C-3A/CC-3A</p>	 <p>CC-4A</p>
 <p>C-5A</p>	 <p>C-6A/CC-6A</p>	 <p>C-7A/CC-7A</p>	<p>C-6</p>	

# INDEX REFERENCE BAILEY

Référence Bailey	Page	Référence Bailey	Page	Référence Bailey	Page
<b>B</b>		B20070020.....	M 51	B23006020.....	M 56
B20002250.....	M 50	B22006020.....	M 53	B23006030.....	M 56
B20003667.....	M 50	B22006040.....	M 53	B23006040.....	M 56
B20006020.....	M 50	B22006050.....	M 53	B23006050.....	M 56
B20006040.....	M 50	B22006080.....	M 53	B23006080.....	M 56
B20006050.....	M 50	B22006100.....	M 53	B23006100.....	M 56
B20006080.....	M 50	B22006180.....	M 53	B23006150.....	M 56
B20006100.....	M 50	B22006200.....	M 53	B23006160.....	M 56
B20006100S.....	M 52	B22007100.....	M 53	B23006180.....	M 56
B20006180.....	M 50	B22012025.....	M 50	B23006190.....	M 56
B20006200.....	M 50	B22012050.....	M 53	B23006200.....	M 56
B20006200L.....	M 50	B22012100.....	M 53	B23006250.....	M 56
B20006333.....	M 50	B22012120.....	M 53	B23006300.....	M 56
B20007100.....	M 50	B22012170.....	M 53	B23006333.....	M 56
B20012020.....	M 50	B22014080.....	M 53	B23006350.....	M 56
B20012025.....	M 50	B22014100.....	M 53	B23006500.....	M 56
B20012050.....	M 50	B22016100.....	M 53	B23006666.....	M 56
B20012050S.....	M 52	B22018100.....	M 53	B23006999.....	M 56
B20012100.....	M 50	B22018150.....	M 53	B23008250.....	M 56
B20012100S.....	M 52	B22024020.....	M 53	B23012020.....	M 56
B20012120.....	M 50	B22024025.....	M 53	B23012030.....	M 56
B20012165.....	M 50	B22024025S.....	M 55	B23012050.....	M 56
B20012250.....	M 50	B22024040.....	M 53	B23012100.....	M 57
B20014080.....	M 50	B22024050.....	M 53	B23012120.....	M 57
B20014100.....	M 50	B22024050S.....	M 55	B23012165.....	M 57
B20024020.....	M 50	B22024060.....	M 53	B23012180.....	M 57
B20024025.....	M 50	B22024070.....	M 53	B23012250.....	M 57
B20024025S.....	M 52	B22024080.....	M 53	B23012333.....	M 57
B20024040.....	M 50	B22024080S.....	M 55	B23012417.....	M 57
B20024050.....	M 50	B22024100.....	M 53	B23015001.....	M 56
B20024050S.....	M 52	B22024125.....	M 53	B23015002.....	M 56
B20024060.....	M 50	B22028020.....	M 53	B23015140.....	M 57
B20024080.....	M 50	B22028025.....	M 53	B23018100.....	M 57
B20024080S.....	M 52	B22028040.....	M 53	B23024025.....	M 57
B20024100.....	M 50	B22028060.....	M 53	B23024050.....	M 57
B20024125.....	M 50	B22028070.....	M 54	B230240505RC.....	M 57
B20024170.....	M 51	B22030020.....	M 54	B23024060.....	M 57
B20028020.....	M 51	B22030025.....	M 54	B23024080.....	M 57
B20028025.....	M 51	B22030030.....	M 54	B23024100.....	M 57
B20028040.....	M 51	B22030040.....	M 54	B23024125.....	M 57
B20028040R.....	M 51	B22030050.....	M 54	B23024165.....	M 57
B20028050.....	M 51	B22030050S.....	M 55	B23026038.....	M 57
B20028060.....	M 51	B22030065.....	M 54	B23026115.....	M 57
B20028070.....	M 51	B22030070.....	M 54	B23028040.....	M 57
B20028100.....	M 51	B22030100.....	M 54	B23028060.....	M 57
B20030025.....	M 51	B22036020.....	M 54	B23028070.....	M 57
B20030030.....	M 51	B22036025.....	M 54	B23028080.....	M 57
B20030040.....	M 51	B22036030.....	M 54	B23030002.....	M 57
B20030040S.....	M 52	B22036035.....	M 54	B23030020.....	M 57
B20030050.....	M 51	B22036040.....	M 54	B23030033.....	M 57
B20030050S.....	M 52	B22036050.....	M 54	B23030040.....	M 57
B20030060.....	M 51	B22048020.....	M 54	B23030050.....	M 57
B20030065.....	M 51	B22048020S.....	M 55	B23030065.....	M 57
B20030065S.....	M 52	B22048025.....	M 54	B23030070.....	M 57
B20030070.....	M 51	B22048030.....	M 54	B23030080.....	M 57
B20030100.....	M 51	B22048040.....	M 54	B23030100.....	M 57
B20036020.....	M 51	B22048050.....	M 54	B23032100.....	M 57
B20036040.....	M 51	B22052025.....	M 54	B23036020.....	M 57
B20036040S.....	M 52	B22060020.....	M 54	B23036030.....	M 57
B20036050.....	M 51	B22060020S.....	M 55	B23036040.....	M 57
B20036050S.....	M 52	B22060025.....	M 54	B23036050.....	M 57
B20048020.....	M 51	B22060040.....	M 54	B23036055.....	M 58
B20048025.....	M 51	B22060050.....	M 54	B23036080.....	M 58
B20048030.....	M 51	B22070020.....	M 54	B23036085.....	M 58
B20048040.....	M 51	B22070040.....	M 54	B23040075.....	M 58
B20048050.....	M 51	B22080020.....	M 54	B23042045.....	M 58
B20060020.....	M 51	B23002200.....	M 56	B23042050.....	M 58
B20060020S.....	M 52	B23002500.....	M 56	B23042070.....	M 58
B20060025.....	M 51	B23002600.....	M 56	B23045002.....	M 57
B20060040.....	M 51	B23004250.....	M 56	B23045003.....	M 57
B20060050.....	M 51	B23004313.....	M 56	B23048020.....	M 58

# INDEX REFERENCE BAILEY

Référence Bailey	Page	Référence Bailey	Page	Référence Bailey	Page
B23048025	M 58	B24035050	M 69	B28012330	M 62
B23048040	M 58	B24048050	M 69	B28012417	M 62
B23048050	M 58	B24060030	M 69	B28014080	M 62
B23048060	M 58	B28001050	M 60	B28014100	M 62
B23060002	M 58	B28001150	M 60	B28014200	M 62
B23060003	M 58	B28002060	M 60	B28014240	M 62
B23060020	M 58	B28002150	M 60	B28015002	M 61
B23060033	M 58	B28002200	M 60	B28015004	M 61
B23060040	M 58	B28002300	M 60	B28015050	M 62
B23060050	M 58	B28002500	M 60	B28015100	M 62
B23070002	M 58	B28002600	M 60	B28015200	M 62
B23070030	M 58	B28002998	M 60	B28016150	M 62
B23070040	M 58	B28003150	M 60	B28018050	M 62
B23080020	M 58	B28003200	M 60	B28018100	M 62
B23080030	M 58	B28003201	M 60	B28018170	M 62
B23080040	M 58	B28003250	M 60	B28024025	M 62
B23085030	M 58	B28003650	M 60	B28024040	M 62
B23100040	M 58	B28004040	M 60	B28024050	M 62
B23110022	M 58	B28004100	M 60	B28024060	M 62
B23130015	M 58	B28004250	M 60	B28024080	M 62
B23130016	M 58	B28004300	M 60	B280240802	M 62
B23130020	M 58	B28004500	M 60	B28024100	M 62
B23130021	M 58	B28005050	M 60	B28024125	M 62
B23220009	M 58	B28005070	M 60	B28024165	M 62
B23220014	M 58	B28005090	M 60	B28024208	M 62
B23240010	M 58	B28005150	M 60	B28027075	M 62
B23240013	M 58	B28005300	M 60	B28028022	M 62
B24002200	M 68	B28005900	M 60	B28028025	M 62
B24002300	M 68	B28006020	M 60	B28028040	M 62
B24002301	M 68	B28006030	M 60	B28028050	M 62
B24002500	M 68	B28006050	M 60	B28028060	M 62
B24002999	M 68	B28006075	M 60	B28028070	M 62
B24003200	M 68	B28006090	M 61	B28028080	M 62
B24004300	M 68	B28006100	M 61	B28028100	M 62
B24004301	M 68	B28006150	M 61	B28028107	M 62
B24006050	M 68	B28006151	M 61	B28028125	M 62
B24006100	M 68	B28006180	M 61	B28028170	M 62
B24006150	M 68	B28006200	M 61	B28028200	M 63
B24006160	M 68	B28006250	M 61	B28030002	M 62
B24006180	M 68	B28006251	M 61	B28030004	M 62
B24006300	M 68	B28006300	M 61	B28030020	M 63
B24006301	M 68	B28006300BL	M 61	B28030025	M 63
B24006350	M 68	B28006301	M 61	B28030030	M 63
B24006500	M 68	B28006302	M 61	B28030033	M 63
B24006830	M 68	B28006320	M 61	B28030040	M 63
B24006999	M 68	B28006333	M 61	B28030050	M 63
B24007100	M 68	B28006350	M 61	B28030065	M 63
B24007300	M 68	B28006500	M 61	B28030080	M 63
B24010050	M 68	B28006700	M 61	B28030100	M 63
B24012050	M 68	B28006830	M 61	B28030167	M 63
B24012100	M 68	B28006999	M 61	B28032002	M 63
B24012165	M 68	B28007100	M 61	B28032170	M 63
B24012185	M 68	B28007300	M 61	B28036020	M 63
B24012200	M 68	B28007570	M 61	B28036030	M 63
B24012250	M 68	B28008100	M 61	B28036040	M 63
B24012333	M 68	B28008250	M 61	B28036050	M 63
B24014060	M 69	B28008300	M 61	B28036055	M 63
B24014120	M 69	B28010050	M 61	B28036085	M 63
B24018100	M 69	B28010135	M 61	B28036100	M 63
B24024050	M 69	B28010200	M 61	B28036110	M 63
B24024080	M 69	B28012030	M 61	B28042025	M 63
B24024100	M 69	B28012050	M 61	B28042028	M 63
B24024120	M 69	B28012080	M 61	B28042045	M 63
B24024125	M 69	B28012100	M 61	B28042050	M 63
B24024208	M 69	B28012120	M 61	B28042070	M 63
B24028050	M 69	B28012150	M 61	B28045002	M 63
B24028070	M 69	B28012165	M 61	B28045004	M 63
B24030040	M 69	B28012183	M 61	B28048020	M 63
B24030050	M 69	B28012200	M 61	B28048025	M 63
B24030065	M 69	B28012250	M 62	B28048040	M 63
B24030100	M 69	B280122502	M 62	B28048050	M 63

# INDEX REFERENCE BAILEY

Référence Bailey	Page	Référence Bailey	Page	Référence Bailey	Page
B28048060.....	M 63	B29012833.....	M 70	B35030007.....	M 99
B28048080.....	M 63	B29014120.....	M 70	B35030010.....	M 99
B28048105.....	M 63	B29014240.....	M 70	B35036003.....	M 99
B28050050.....	M 63	B29016187.....	M 70	B35036005.....	M 99
B28050080.....	M 63	B29017175.....	M 71	B35040003.....	M 99
B28050100.....	M 64	B29020250.....	M 71	B35042005.....	M 99
B28052060.....	M 64	B29024050.....	M 71	B35048003.....	M 99
B28055050.....	M 64	B29024080.....	M 71	B35048005.....	M 99
B28060002.....	M 63	B29024125.....	M 71	B35060002.....	M 99
B28060004.....	M 63	B29024165.....	M 71	B35060003.....	M 99
B28060020.....	M 64	B29024208.....	M 71	B35060005.....	M 99
B28060030.....	M 64	B29024250.....	M 71	B35085004.....	M 100
B28060033.....	M 64	B29028170.....	M 71	B35085005.....	M 100
B28060040.....	M 64	B29030040.....	M 71	B35110003.....	M 100
B28060050.....	M 64	B29030065.....	M 71	B35110005.....	M 100
B28060060.....	M 64	B29030080.....	M 71	B35130005.....	M 100
B28060085.....	M 64	B29030100.....	M 71	B35140007.....	M 100
B28065085.....	M 64	B29030165.....	M 71	B35160005.....	M 100
B28070020.....	M 64	B29048060.....	M 71	B35220003.....	M 100
B28070040.....	M 64	B29048105.....	M 71	B35220005.....	M 100
B28080003.....	M 64	B29060085.....	M 71	B35255005.....	M 100
B28080025.....	M 64	B29130020.....	M 71	B35260005.....	M 100
B28080040.....	M 64	B30006001.....	M 98	B35260007.....	M 100
B28085024.....	M 64	B30006003.....	M 98	B35260010.....	M 100
B28085035.....	M 64	B30006005.....	M 98	B35300005.....	M 100
B28085050.....	M 64	B30012001.....	M 98	B35300010.....	M 100
B28110022.....	M 64	B30012002.....	M 98	B39024125.....	M 66
B28130015.....	M 64	B30012003.....	M 98	B39030100.....	M 66
B28130016.....	M 64	B30012005.....	M 98	B39048063.....	M 66
B28130018.....	M 64	B300240012.....	M 98	B39053130.....	M 66
B28130020.....	M 64	B30024002.....	M 98	B39060050.....	M 66
B28130021.....	M 64	B30024003.....	M 98	B39090003.....	M 66
B28130022.....	M 64	B30024005.....	M 98	B39130020.....	M 66
B28130030.....	M 64	B30030002.....	M 98	B39160022.....	M 66
B28130038.....	M 64	B30030003.....	M 98	B39220014.....	M 66
B28150020.....	M 64	B30030005.....	M 98	B39230017.....	M 66
B28160020.....	M 64	B300360018.....	M 98	B45006003.....	M 101
B28220009.....	M 64	B30036002.....	M 98	B45006004.....	M 101
B28220014.....	M 64	B30036005.....	M 98	B45006005.....	M 101
B282200142.....	M 64	B30048002.....	M 98	B45012004.....	M 101
B28220018.....	M 64	B30048003.....	M 98	B45012005.....	M 101
B28220023.....	M 64	B30048005.....	M 98	B45012010.....	M 101
B28230013.....	M 64	B30060001.....	M 98	B45012015.....	M 101
B28240010.....	M 64	B30060003.....	M 98	B450120152.....	M 101
B28240013.....	M 64	B30060005.....	M 98	B45024003.....	M 101
B28240017.....	M 64	B30130002.....	M 98	B45024004.....	M 101
B29002500.....	M 70	B30130003.....	M 98	B45024005.....	M 101
B29002501.....	M 70	B30130005.....	M 98	B45024006.....	M 101
B29002502.....	M 70	B30220003.....	M 98	B45024010.....	M 101
B29002999.....	M 70	B30220005.....	M 98	B45024015.....	M 101
B29003600.....	M 70	B30260005.....	M 98	B45030003.....	M 101
B29006180.....	M 70	B30260007.....	M 98	B45030005.....	M 101
B29006200.....	M 70	B35006001.....	M 99	B45030007.....	M 101
B29006300.....	M 70	B35006002.....	M 99	B45030010.....	M 101
B29006320.....	M 70	B35006005.....	M 99	B45036005.....	M 101
B29006350.....	M 70	B35012001.....	M 99	B45042005.....	M 101
B29006400.....	M 70	B35012002.....	M 99	B45048005.....	M 101
B29006500.....	M 70	B35012003.....	M 99	B45048010.....	M 101
B29006500BL.....	M 70	B35012005.....	M 99	B45060004.....	M 101
B29006667.....	M 70	B35012010.....	M 99	B45060005.....	M 101
B29006830.....	M 70	B35024002.....	M 99	B45060010.....	M 101
B29006999.....	M 70	B35024003.....	M 99	B45080006.....	M 101
B29007300BL.....	M 70	B35024004.....	M 99	B45110010.....	M 101
B29007410.....	M 70	B35024005.....	M 99	B45130005.....	M 101
B29010400.....	M 70	B35024010.....	M 99	B45130015.....	M 101
B29012125.....	M 70	B350240104.....	M 99	B45140007.....	M 101
B29012250.....	M 70	B35030002.....	M 99	B45140010.....	M 102
B29012333.....	M 70	B35030003.....	M 99	B45150007.....	M 102
B29012417.....	M 70	B35030004.....	M 99	B45220010.....	M 102
B29012500.....	M 70	B35030005.....	M 99	B45240015.....	M 102
B29012625.....	M 70	B350300054.....	M 99	B45250015.....	M 102

# INDEX REFERENCE BAILEY

Référence Bailey	Page	Référence Bailey	Page	Référence Bailey	Page
B45260007	M 102	B54130010	M 104	BP36060402	M 13
B45260010	M 102	B54140005	M 104	BP36060751	M 13
B45260015	M 102	B54140007	M 104	BP36062001	M 13
B45380010	M 102	B54140010	M 104	BP36062002	M 13
B48006010	M 105	B54150005	M 104	BP36062003	M 13
B48006015	M 105	B54160010	M 104	BP3606200F	M 13
B48012005	M 105	B54220005	M 104	BP36100401	M 13
B48012010	M 105	B54220015	M 104	BP36120401	M 13
B48012015	M 105	B54230015	M 104	BP36120601	M 13
B48012025	M 105	B54240015	M 104	BP36140801	M 13
B48024005	M 105	B54250015	M 104	BP36140802	M 13
B48024007	M 105	B54260005	M 104	BP36180401	M 13
B48024010	M 105	B54260006	M 104	BP36240501	M 13
B48024015	M 105	B54260007	M 104	BP36280241	M 13
B48024025	M 105	B54260010	M 104	BP36280351	M 13
B48030010	M 105	B54260015	M 104	BP36280401	M 13
B48042005	M 105	B54380010	M 104	BP36280402	M 13
B48050010	M 105	BP13022001	M 8	BP36280601	M 13
B48075015	M 105	BP13050601	M 8	BP36480251	M 13
B48130005	M 105	BP13050751	M 8	BP36600201	M 13
B48130010	M 105	BP13051151	M 8	BR23006333	M 59
B48130015	M 105	BP13060751	M 8	BR23012165	M 59
B48240025	M 105	BP13120301	M 8	BR23024080	M 59
B48260007	M 105	BP13120601	M 8	BR230240802	M 59
B48260010	M 105	BP13140651	M 8	BR230280802	M 59
B48260015	M 105	BP13280241	M 8	BR23030040	M 59
B54006003	M 103	BP13280401	M 8	BR23030065	M 59
B54006005	M 103	BP137714	M 11	BR23030070	M 59
B54006010	M 103	BP137839	M 11	BR23036055	M 59
B54006015	M 103	BP138097	M 11	BR23048040	M 59
B54012004	M 103	BP23050601	M 9	BR23060020	M 59
B54012005	M 103	BP23050751	M 9	BR28006333	M 65
B54012010	M 103	BP23061151	M 9	BR28012165	M 65
B54012015	M 103	BP23120501	M 9	BR28024050	M 65
B54024002	M 103	BP23120601	M 9	BR28024080	M 65
B54024003	M 103	BP23140651	M 9	BR280240802	M 65
B54024004	M 103	BP23180261	M 9	BR28028040	M 65
B54024005	M 103	BP23240201	M 9	BR28030065	M 65
B54024007	M 103	BP23240241	M 9	BR28036055	M 65
B54024010	M 103	BP23280241	M 9	BS28006300	M 72
B54024015	M 103	BP23280401	M 9	BS28012165	M 72
B54024025	M 103	BP23300201	M 9	BS28012250	M 72
B54027005	M 103	BP23360201	M 9	BS28024125	M 72
B54027010	M 103	BP24050601	M 12	BS28030067	M 72
B54027015	M 103	BP24060601	M 12	BS28030100	M 72
B54030003	M 103	BP24060602	M 12	BS28048062	M 72
B54030005	M 103	BP24062001	M 12	BS28065046	M 72
B54030007	M 103	BP24120401	M 12	BS28065085	M 72
B54030010	M 103	BP24120501	M 12	BS28080040	M 72
B54030015	M 103	BP24140801	M 12	BS28130020	M 72
B54036005	M 103	BP24160301	M 12	BT35024100	M 67
B54040010	M 103	BP24240351	M 12	BT35050055	M 67
B54042003	M 103	BP24280241	M 12		
B54042005	M 103	BP24280251	M 12		
B54042010	M 103	BP24280401	M 12	<b>E</b>	
B54042015	M 103	BP24360201	M 12	E23001220	M 73
B54048003	M 104	BP24480251	M 12	E23002200	M 73
B54048005	M 104	BP33050601	M 10	E23002300	M 73
B54048007	M 104	BP33050751	M 10	E23002400	M 73
B54048010	M 104	BP33120401	M 10	E23003301	M 73
B54048015	M 104	BP33120601	M 10	E23003304	M 73
B54050010	M 104	BP33180261	M 10	E23004250	M 73
B54060004	M 104	BP33240201	M 10	E23004300	M 73
B54060005	M 104	BP33280241	M 10	E23006050	M 73
B54060007	M 104	BP36022001	M 13	E23006100	M 73
B54060010	M 104	BP36023501	M 13	E23006150	M 73
B54080005	M 104	BP36030151	M 13	E23006180	M 73
B54080007	M 104	BP36031901	M 13	E23006200	M 73
B54095010	M 104	BP36050601	M 13	E23006320	M 73
B54110005	M 104	BP36051151	M 13	E23006333	M 73
B54130005	M 104	BP36060401	M 13	E23006350	M 73
				E23006500	M 73

## INDEX REFERENCE BAILEY

Référence Bailey	Page	Référence Bailey	Page	Référence Bailey	Page
E23012020.....	M 73	E24006180.....	M 86	E28006302.....	M 76
E23012050.....	M 73	E24006250.....	M 87	E28006320.....	M 76
E23012100.....	M 73	E24006300.....	M 87	E28006333.....	M 75
E23012120.....	M 73	E24006301.....	M 87	E28006350.....	M 76
E23012165.....	M 73	E24006333.....	M 86	E28006500.....	M 76
E23012250.....	M 73	E24006350.....	M 87	E28006700.....	M 76
E23015002.....	M 73	E24006484.....	M 87	E28006830.....	M 76
E23015050.....	M 73	E24006500.....	M 87	E28006999.....	M 76
E23015140.....	M 73	E24006600.....	M 87	E28007100.....	M 76
E23018100.....	M 73	E24006830.....	M 87	E28007300.....	M 76
E23024025.....	M 73	E24007100.....	M 87	E28007320.....	M 76
E23024040.....	M 73	E24007300.....	M 87	E28008100.....	M 76
E23024050.....	M 74	E24010050.....	M 87	E28008150.....	M 76
E23024060.....	M 74	E24012040.....	M 87	E28008300.....	M 76
E23024080.....	M 74	E24012050.....	M 87	E28008375.....	M 76
E23024125.....	M 74	E24012100.....	M 87	E28010050.....	M 76
E23028040.....	M 74	E24012165.....	M 87	E28010200.....	M 76
E23028080.....	M 74	E24012185.....	M 87	E28012020.....	M 76
E23030033.....	M 74	E24012200.....	M 87	E28012050.....	M 76
E23030040.....	M 74	E24012250.....	M 87	E28012100.....	M 76
E23030050.....	M 74	E24012400.....	M 87	E28012120.....	M 76
E23030065.....	M 74	E24014060.....	M 87	E28012125.....	M 76
E23030080.....	M 74	E24018100.....	M 87	E28012165.....	M 76
E23030100.....	M 74	E24019040.....	M 87	E28012183.....	M 76
E23036050.....	M 74	E24019100.....	M 87	E28012200.....	M 76
E23036055.....	M 74	E24024050.....	M 87	E28012250.....	M 76
E23036083.....	M 74	E24024080.....	M 87	E28012415.....	M 76
E23042048.....	M 74	E24024100.....	M 87	E28014080.....	M 76
E23048020.....	M 74	E24024125.....	M 87	E28014100.....	M 76
E23048025.....	M 74	E24024210.....	M 87	E28014200.....	M 76
E23048040.....	M 74	E24028050.....	M 87	E28015002.....	M 76
E23048060.....	M 74	E24030065.....	M 87	E28015050.....	M 76
E23060020.....	M 74	E24030100.....	M 87	E28015133.....	M 76
E23060035.....	M 74	E24036050.....	M 87	E28015200.....	M 76
E23060040.....	M 74	E24048030.....	M 87	E28016050.....	M 77
E23060050.....	M 74	E24048050.....	M 87	E28016100.....	M 77
E23070029.....	M 74	E24060040.....	M 87	E28018020.....	M 77
E23080020.....	M 74	E28001500.....	M 75	E28018100.....	M 77
E23080040.....	M 74	E28002100.....	M 75	E28018110.....	M 77
E23130020.....	M 74	E28002200.....	M 75	E28018170.....	M 77
E23220014.....	M 74	E28002300.....	M 75	E28019040.....	M 77
E23240017.....	M 74	E28002500.....	M 75	E28019090.....	M 77
E24001090.....	M 86	E28002999.....	M 75	E28024025.....	M 77
E24001150.....	M 86	E28003070.....	M 75	E28024040.....	M 77
E24001151.....	M 86	E28003200.....	M 75	E28024050.....	M 77
E24001200.....	M 86	E28003300.....	M 75	E28024060.....	M 77
E24001250.....	M 86	E28003700.....	M 75	E28024080.....	M 77
E24001300.....	M 86	E28004040.....	M 75	E28024100.....	M 77
E24002060.....	M 86	E28004100.....	M 75	E28024125.....	M 77
E24002100.....	M 86	E28004250.....	M 75	E28024165.....	M 77
E24002200.....	M 86	E28004300.....	M 75	E28024210.....	M 77
E24002201.....	M 86	E28004301.....	M 75	E28028040.....	M 77
E24002300.....	M 86	E28004400.....	M 75	E28028050.....	M 77
E24002301.....	M 86	E28004500.....	M 75	E28028070.....	M 77
E24002500.....	M 86	E28004600.....	M 75	E28028100.....	M 77
E24003070.....	M 86	E28004750.....	M 75	E28028170.....	M 77
E24003150.....	M 86	E28005090.....	M 75	E28030002.....	M 77
E24003200.....	M 86	E28005150.....	M 75	E28030040.....	M 77
E24003300.....	M 86	E28006050.....	M 75	E28030050.....	M 77
E24003301.....	M 86	E28006060.....	M 75	E28030065.....	M 77
E24004040.....	M 86	E28006075.....	M 75	E28030080.....	M 77
E24004300.....	M 86	E28006100.....	M 75	E28030100.....	M 77
E24004500.....	M 86	E28006101.....	M 76	E28030165.....	M 77
E24005300.....	M 86	E28006102.....	M 76	E28036033.....	M 77
E24005500.....	M 86	E28006150.....	M 76	E28036050.....	M 77
E24006040.....	M 86	E28006152.....	M 76	E28036055.....	M 77
E24006050.....	M 86	E28006180.....	M 75	E28036085.....	M 77
E24006060.....	M 87	E28006200.....	M 75	E28042045.....	M 77
E24006100.....	M 86	E28006250.....	M 76	E28042070.....	M 77
E24006150.....	M 87	E28006300.....	M 76	E28042120.....	M 77
E24006151.....	M 86	E28006301.....	M 75	E28045002.....	M 77

# INDEX REFERENCE BAILEY

Référence Bailey	Page	Référence Bailey	Page	Référence Bailey	Page
E28045004	M 77	E29008450	M 88	E30130040	M 111
E28048002	M 77	E29012100	M 88	E30220014	M 111
E28048020	M 78	E29012170	M 89	E30220023	M 111
E28048040	M 78	E29012200	M 89	E30230013	M 111
E28048050	M 78	E29012250	M 89	E30260019	M 111
E28048060	M 78	E29012330	M 89	E30260027	M 111
E28048080	M 78	E29012410	M 89	E34006001	M 106
E28048100	M 78	E29012500	M 89	E34012002	M 106
E28048105	M 78	E29012500GR	M 89	E34012003	M 106
E28050050	M 78	E29014500	M 89	E34012005	M 106
E28052060	M 78	E29016188	M 89	E34012010	M 106
E28060002	M 78	E29019040	M 89	E34018002	M 106
E28060004	M 78	E29024050	M 89	E34024002	M 106
E28060005	M 78	E29024080	M 89	E34024003	M 106
E28060020	M 78	E29024125	M 89	E34024005	M 106
E28060030	M 78	E29024150	M 89	E34028002	M 106
E28060033	M 78	E29024210	M 89	E34030002	M 106
E28060040	M 78	E29028150	M 89	E34030003	M 106
E28060050	M 78	E29030100	M 89	E34030005	M 106
E28060060	M 78	E29030165	M 89	E34042005	M 106
E28060070	M 78	E29035050	M 89	E34048002	M 106
E28060085	M 78	E29036140	M 89	E34048003	M 106
E28070020	M 78	E29042050	M 89	E34060002	M 106
E28070040	M 78	E29048060	M 89	E34060005	M 106
E28080025	M 78	E29048105	M 89	E34110003	M 106
E28080035	M 78	E29060083	M 89	E34110005	M 106
E28080040	M 78	E29130020	M 89	E34130006	M 106
E28085035	M 78	E30004250	M 110	E34220005	M 106
E28110027	M 78	E30004750	M 110	E35006001	M 112
E28130015	M 78	E30006180	M 110	E35006002	M 112
E28130020	M 78	E30006333	M 110	E35006005	M 112
E28130021	M 78	E30006500	M 110	E35008003	M 112
E28130038	M 78	E30006850	M 110	E35012002	M 112
E28160020	M 78	E30012100	M 110	E35012003	M 112
E28220009	M 78	E30012120	M 110	E35012005	M 112
E28220014	M 78	E30012165	M 110	E35024002	M 112
E28220018	M 78	E30012250	M 110	E35024003	M 112
E28220023	M 78	E30012410	M 110	E35024004	M 112
E28230013	M 78	E30024040	M 110	E35024005	M 112
E28230022	M 78	E30024050	M 110	E35030003	M 112
E28240004	M 79	E30024080	M 110	E35030005	M 112
E28240010	M 78	E30024125	M 110	E35036003	M 112
E28240012	M 79	E30024210	M 110	E35036005	M 112
E28240017	M 79	E30030002	M 110	E35042005	M 112
E29002270	M 88	E30030050	M 110	E35048003	M 112
E29002350	M 88	E30030065	M 110	E35048005	M 112
E29002500	M 88	E30030080	M 110	E35060001	M 112
E29002625	M 88	E30030100	M 110	E35060002	M 112
E29002997	M 88	E30030167	M 110	E35060003	M 112
E29002998	M 88	E30036050	M 110	E35060005	M 112
E29002999	M 88	E30036055	M 110	E35080005	M 112
E29003200	M 88	E30036080	M 110	E35110005	M 112
E29004300	M 88	E30036140	M 110	E35130002	M 112
E29004600	M 88	E30042050	M 110	E35130005	M 112
E29004700	M 88	E30042070	M 110	E35130015	M 112
E29005050	M 88	E30042120	M 110	E35140007	M 112
E29005100	M 88	E30045002	M 110	E35150005	M 112
E29005150	M 88	E30048040	M 111	E35160005	M 112
E29005500	M 88	E30048060	M 111	E35230003	M 113
E29006050	M 88	E30048105	M 111	E35260003	M 113
E29006250	M 88	E30060002	M 111	E35260005	M 113
E29006320	M 88	E30060020	M 111	E35260007	M 113
E29006350	M 88	E30060033	M 111	E35260010	M 113
E29006400	M 88	E30060040	M 111	E38030060	M 80
E29006450	M 88	E30060050	M 111	E38030100	M 80
E29006500	M 88	E30060085	M 111	E38048060	M 80
E29006500BL	M 88	E30070002	M 111	E38060030	M 80
E29006830	M 88	E30080035	M 111	E38060050	M 80
E29006999	M 88	E30080063	M 111	E38060085	M 80
E29007240	M 88	E30110045	M 111	E38130030	M 80
E29007300	M 88	E30130020	M 111	E38160025	M 80

## INDEX REFERENCE BAILEY

Référence Bailey	Page	Référence Bailey	Page	Référence Bailey	Page
E38220014.....	M 80	E48024005.....	M 119	E54030015.....	M 117
E38230018.....	M 80	E48024010.....	M 119	E54030016.....	M 117
E44006003.....	M 107	E48024015.....	M 119	E54032005.....	M 117
E44012003.....	M 107	E48024025.....	M 119	E54036005.....	M 117
E44024002.....	M 107	E48024040.....	M 119	E54042003.....	M 117
E44024003.....	M 107	E48030005.....	M 119	E54042005.....	M 117
E44024005.....	M 107	E48042005.....	M 119	E54042007.....	M 117
E44030005.....	M 107	E48048015.....	M 119	E54042010.....	M 117
E44048005.....	M 107	E48060007.....	M 119	E54042015.....	M 117
E44060005.....	M 107	E48060010.....	M 119	E54045005.....	M 117
E44130005.....	M 107	E48060015.....	M 119	E54045010.....	M 117
E44130006.....	M 107	E48065015.....	M 119	E54048003.....	M 117
E44140010.....	M 107	E48080007.....	M 119	E54048005.....	M 117
E44140015.....	M 107	E48130005.....	M 119	E54048010.....	M 117
E44220010.....	M 107	E48130010.....	M 119	E54048010F.....	M 117
E44260007.....	M 107	E48130015.....	M 119	E54048015.....	M 117
E44260010.....	M 107	E48220010.....	M 119	E54060003.....	M 117
E45006001.....	M 114	E48235015.....	M 119	E540600035.....	M 117
E45006005.....	M 114	E48235025.....	M 119	E54060004.....	M 117
E45012003.....	M 114	E48260007.....	M 119	E54060005.....	M 117
E45012005.....	M 114	E48260010.....	M 119	E54060007.....	M 117
E45012010.....	M 114	E48260015.....	M 119	E54060010.....	M 117
E45014005.....	M 114	E50024125.....	M 81	E54060011.....	M 117
E45024002.....	M 114	E50030100.....	M 81	E54060015.....	M 117
E45024003.....	M 114	E50060050.....	M 81	E54065005.....	M 117
E45024005.....	M 114	E50130030.....	M 81	E54065007.....	M 117
E45024007.....	M 114	E50160025.....	M 81	E54065010.....	M 117
E45024010.....	M 114	E50230018.....	M 81	E54065015.....	M 117
E45024015.....	M 114	E53024005.....	M 108	E54070004.....	M 117
E45030003.....	M 114	E53030010.....	M 108	E54070005.....	M 117
E45030005.....	M 114	E53060005.....	M 108	E54072015.....	M 117
E45030007.....	M 114	E53095010.....	M 108	E54080005.....	M 117
E45030010.....	M 114	E53130005.....	M 108	E54080007.....	M 117
E45036005.....	M 114	E53140007.....	M 108	E54080010.....	M 117
E45042005.....	M 114	E53140010.....	M 108	E54080015.....	M 117
E45048005.....	M 114	E53230015.....	M 108	E54095010.....	M 117
E45048010.....	M 114	E53260007.....	M 108	E54110010.....	M 117
E45060005.....	M 114	E53260010.....	M 108	E54110015.....	M 117
E45060007.....	M 114	E53260015.....	M 108	E54130005.....	M 118
E45060010.....	M 114	E54004005.....	M 116	E54130015.....	M 118
E45130005.....	M 114	E54006001.....	M 116	E54140007.....	M 118
E45140007.....	M 114	E54006003.....	M 116	E54140010.....	M 118
E45140010.....	M 114	E54006004.....	M 116	E54150005.....	M 118
E45160005.....	M 114	E54006005.....	M 116	E54160007.....	M 118
E45220010.....	M 114	E54006010.....	M 116	E54220005.....	M 118
E45260005.....	M 114	E54006015.....	M 116	E54220010.....	M 118
E45260007.....	M 114	E54008003.....	M 116	E54220015.....	M 118
E45260010.....	M 115	E54012002.....	M 116	E54240015.....	M 118
E45260015.....	M 115	E54012003.....	M 116	E54260003.....	M 118
E45380010.....	M 115	E54012004.....	M 116	E54260005.....	M 118
E47006006.....	M 109	E54012005.....	M 116	E54260006.....	M 118
E47012006.....	M 109	E54012007.....	M 116	E54260007.....	M 118
E47024005.....	M 109	E54012010.....	M 116	E54260010.....	M 118
E47024006.....	M 109	E54012015.....	M 116	E542600105.....	M 118
E47030006.....	M 109	E54014005.....	M 116	E54260015.....	M 118
E47032006.....	M 109	E54024002.....	M 116	E54380010.....	M 118
E47048006.....	M 109	E54024003.....	M 116	EB0220250.....	M 94
E47060006.....	M 109	E54024004.....	M 116	EB0220300.....	M 94
E47075006.....	M 109	E54024005.....	M 116	EB0220400.....	M 94
E47110015.....	M 109	E54024007.....	M 116	EB0240300.....	M 94
E47120006.....	M 109	E54024010.....	M 116	EB0240400.....	M 94
E47130003.....	M 109	E54024015.....	M 116	EB0240500.....	M 94
E47130004.....	M 109	E54024025.....	M 116	EB0250250.....	M 94
E47250007.....	M 109	E54030002.....	M 116	EB0250300.....	M 94
E47250010.....	M 109	E54030003.....	M 116	EB0330300.....	M 94
E47250015.....	M 109	E54030004.....	M 116	EB0370300.....	M 94
E48012005.....	M 119	E54030005.....	M 116	EB0480300.....	M 94
E48012010.....	M 119	E54030007.....	M 116	EK0250750.....	M 91
E48012015.....	M 119	E54030009.....	M 116	EK0480750.....	M 91
E48012025.....	M 119	E54030010.....	M 117	EK2902240.....	M 91
E48024003.....	M 119	E54030011.....	M 117	EK2902313.....	M 91



# INDEX REFERENCE BAILEY

Référence Bailey	Page	Référence Bailey	Page	Référence Bailey	Page
MF14120401	M 17	MS06010751	M 24	NB23220GC	M 142
MF14120601	M 17	MS06011101	M 24	NB23220GG	M 142
MF14121001	M 17	MS06020601	M 24	NB23220PC	M 142
MF14240201	M 17	MS06022001	M 24	NB23220PG	M 142
MF14280201	M 17	MS06023001	M 24	NB23380GC	M 142
MF14280241	M 17	MS06023501	M 24	NB23380GG	M 142
MF14280401	M 17	MS06030151	M 24	NB23380PC	M 142
MG06010601	M 21	MS06032001	M 24	NB23380PG	M 142
MG06020601	M 21	MS06040601	M 24	NB28065PC	M 142
MG06023501	M 21	MS06043501	M 24	NB28110GC	M 142
MG0602350L	M 21	MS06050601	M 24	NB28110GG	M 142
MG06050401	M 21	MS06051151	M 24	NB28110PC	M 142
MG06050602	M 21	MS06060401	M 24	NB28110PG	M 142
MG06060401	M 21	MS06060501	M 24	NB28220GC	M 142
MG06060402	M 21	MS06060601	M 24	NB28220GG	M 142
MG06060601	M 21	MS06061001	M 24	NB28220PC	M 142
MG06060751	M 21	MS06061501	M 24	NB28220PG	M 142
MG06061251	M 21	MS06062001	M 24	NB28380GC	M 142
MG06061502	M 21	MS06062002	M 24	NB28380GG	M 142
MG06062001	M 21	MS06081501	M 24	NB28380PC	M 142
MG06062002	M 21	MS06100151	M 24	NB28380PG	M 142
MG06062003	M 21	MS06120401	M 24	NB30065PC	M 144
MG06100151	M 21	MS06120501	M 24	NB30110GC	M 144
MG06100401	M 21	MS06120601	M 24	NB30110GG	M 144
MG06120201	M 21	MS06120801	M 24	NB30110PC	M 144
MG06120401	M 21	MS06121001	M 24	NB30110PG	M 144
MG06120601	M 21	MS06121201	M 24	NB30220GC	M 144
MG06120751	M 21	MS06121271	M 24	NB30220GG	M 144
MG06121001	M 21	MS06140201	M 25	NB30220PC	M 144
MG06121201	M 21	MS06140401	M 25	NB30220PG	M 144
MG06140201	M 21	MS06140501	M 25	NB30380GC	M 144
MG06140501	M 21	MS06140801	M 25	NB30380PC	M 144
MG06140801	M 21	MS06140802	M 25	NB30380PG	M 144
MG06140802	M 21	MS06180401	M 25	NB35110GC	M 144
MG06140803	M 21	MS06240201	M 25	NB35220GC	M 144
MG06180401	M 21	MS06240351	M 25	NB35380GC	M 144
MG06220401	M 22	MS06240401	M 25	NB54110GC	M 144
MG06240201	M 22	MS06240501	M 25	NB54110PC	M 144
MG06240251	M 22	MS06240601	M 25	NB54220GC	M 144
MG06240351	M 22	MS06240801	M 25	NB54220PC	M 144
MG06240401	M 22	MS06280251	M 25	NB54380GC	M 144
MG06240501	M 22	MS06280401	M 25	NB54380PC	M 144
MG06240601	M 22	MS06280402	M 25	NB60110GC	M 147
MG06240801	M 22	MS06280801	M 25	NB60220GC	M 147
MG06280201	M 22	MS06360201	M 25	NE23110GC	M 143
MG06280241	M 22	MS06480201	M 25	NE23110GG	M 143
MG06280251	M 22	MS06600201	M 25	NE23110PC	M 143
MG06280301	M 22	MT16062001	M 23	NE23220GC	M 143
MG06280302	M 22	MT16140501	M 23	NE23220GG	M 143
MG06280351	M 22	MT16140801	M 23	NE23220PC	M 143
MG06280401	M 22	MT16180501	M 23	NE23220PG	M 143
MG06280402	M 22	MT16240501	M 23	NE23380GC	M 143
MG06280403	M 22	MT16280211	M 23	NE23380PC	M 143
MG06280404	M 22	MT16280401	M 23	NE28110GC	M 143
MG06280601	M 22	MT16600201	M 23	NE28110GG	M 143
MG06280651	M 22	MT18061001	M 23	NE28110PC	M 143
MG06280801	M 22	MT18120501	M 23	NE28110PG	M 143
MG06300401	M 22	MT18180331	M 23	NE28220GC	M 143
MG06320331	M 22	MT18240251	M 23	NE28220GG	M 143
MG06360201	M 22	MT18280201	M 23	NE28220PC	M 143
MG06360301	M 22			NE28220PG	M 143
MG06360401	M 22			NE28380GC	M 143
MG06480201	M 22	<b>N</b>		NE28380GG	M 143
MG06480251	M 22	NB20110GC	M 140	NE28380PC	M 143
MG06480301	M 22	NB20220GC	M 140	NE28380PG	M 143
MG06480302	M 22	NB22085GC	M 140	NE30110GC	M 146
MG06480401	M 22	NB22110GC	M 140	NE30110GG	M 146
MG06480402	M 22	NB22220GC	M 140	NE30110PC	M 146
MG06600201	M 22	NB23110GC	M 142	NE30110PG	M 146
MG06600301	M 22	NB23110GG	M 142	NE30220GC	M 146
MG06700201	M 22	NB23110PC	M 142	NE30220GG	M 146
MS06010601	M 24	NB23110PG	M 142		



# INDEX REFERENCE BAILEY

Référence Bailey	Page	Référence Bailey	Page	Référence Bailey	Page
S73606005.....	M 127	S84406005.....	M 133	SF3624125.....	M 136
S73612003.....	M 127	S84406010.....	M 133	SX84412003.....	M 135
S73612005.....	M 127	S84412003.....	M 133	SX84412003F.....	M 135
S73624002.....	M 127	S84412005.....	M 133	SX84412005.....	M 135
S73624003.....	M 127	S84412010.....	M 133	SX84412005F.....	M 135
S73624005.....	M 127	S84412010F.....	M 133	SX84412006.....	M 135
S73628003.....	M 127	S84412015.....	M 133	SX84412006F.....	M 135
S73630003.....	M 127	S84415005.....	M 133	SX84412010.....	M 135
S73630005.....	M 127	S84418005.....	M 133	SX84412010F.....	M 135
S73648003.....	M 127	S84424001.....	M 133	SX844220072.....	M 135
S73648005.....	M 127	S84424002.....	M 133	SX84424003.....	M 135
S73660003.....	M 127	S84424003.....	M 133	SX84424003F.....	M 135
S73906003.....	M 128	S84424003A.....	M 133	SX84424005.....	M 135
S73906005.....	M 128	S84424003G.....	M 133	SX84424005F.....	M 135
S739120012.....	M 128	S84424003R.....	M 133	SX84424006.....	M 135
S73912003.....	M 128	S84424004.....	M 133	SX84424006F.....	M 135
S73912005.....	M 128	S84424005.....	M 133	SX84424010.....	M 135
S73916003.....	M 128	S84424005G.....	M 133	SX84424010F.....	M 135
S739240012.....	M 128	S84424005R.....	M 133	SXRL4412005.....	M 137
S73924003.....	M 128	S84424010.....	M 133	SXRL4412005F.....	M 137
S73924005.....	M 128	S84424020.....	M 133	SXRL44120085.....	M 137
S73930003.....	M 128	S84430003.....	M 133	SXRL44120085F.....	M 137
S73930005.....	M 128	S84430005.....	M 133	SXRL4412010.....	M 137
S73948005.....	M 128	S84430010.....	M 133	SXRL4412010F.....	M 137
S83006005.....	M 129	S84442005.....	M 133	SXRL4424005.....	M 137
S83006010.....	M 129	S84448003.....	M 133	SXRL4424005F.....	M 137
S83012005.....	M 129	S84448005.....	M 133	SXRL44240085.....	M 137
S83012010.....	M 129	S84460003.....	M 133	SXRL44240085F.....	M 137
S83024005.....	M 129	S84460005.....	M 133	SXRL4424010.....	M 137
S83024010.....	M 129	S84506005.....	M 134	SXRL4424010F.....	M 137
S83606005.....	M 130	S84506010.....	M 134	SXRL44260051F.....	M 137
S83606010.....	M 130	S84506015.....	M 134	SXRL44260085.....	M 137
S83612003.....	M 130	S84506018.....	M 134	SXRL44260085F.....	M 137
S83612005.....	M 130	S84512003.....	M 134		
S83612010.....	M 130	S84512005.....	M 134	<b>T</b>	
S83624003.....	M 130	S84512010.....	M 134	T2304040.....	M 45
S83624005.....	M 130	S84512015.....	M 134	T2305040.....	M 45
S83624010.....	M 130	S84512018.....	M 134	T2306040.....	M 45
S83906000.....	M 131	S84512021.....	M 134	T2310040.....	M 45
S83906003.....	M 131	S84524003.....	M 134	T2312040.....	M 45
S83906005.....	M 131	S84524005.....	M 134	T2316040.....	M 45
S83912000.....	M 131	S84524010.....	M 134	T2318040.....	M 45
S83912001.....	M 131	S84524015.....	M 134	T2324040.....	M 45
S83912003.....	M 131	S84524018.....	M 134	T2328040.....	M 45
S83912005.....	M 131	S84528010.....	M 134	T2348040.....	M 45
S83912010.....	M 131	S84530005.....	M 134	T2806140.....	M 46
S83918005.....	M 131	S84530010.....	M 134	T2812170.....	M 46
S83924001.....	M 131	S84536005.....	M 134	T2824073.....	M 46
S83924002.....	M 131	S84548005.....	M 134	T2828040.....	M 46
S83924003.....	M 131	S84548010.....	M 134	T2848053.....	M 46
S83924003G.....	M 131	S84560003.....	M 134	T2860050.....	M 46
S83924003R.....	M 131	S84560005.....	M 134	T2899025.....	M 46
S83924005.....	M 131	S84560010.....	M 134	T2899026.....	M 46
S83924005G.....	M 131	S84580005.....	M 134	T3006040.....	M 39
S83924005R.....	M 131	S84580010.....	M 134	T3012050.....	M 39
S83924010.....	M 131	SF2612100.....	M 136	T3024020.....	M 39
S83930002.....	M 131	SF3106100.....	M 136	T3024050.....	M 39
S83930003.....	M 131	SF3106101.....	M 136	T3048020.....	M 39
S83930005.....	M 131	SF3106150.....	M 136	T3048040.....	M 39
S83936003.....	M 131	SF3106151.....	M 136	T3060018.....	M 39
S83936005.....	M 131	SF3106250.....	M 136	T4505120.....	M 33
S83948003.....	M 131	SF3106300.....	M 136	T4506020.....	M 33
S83948005.....	M 131	SF3108100.....	M 136	T4506040.....	M 33
S83960003.....	M 131	SF3108150.....	M 136	T4506050.....	M 33
S83960005.....	M 131	SF3108250.....	M 136	T4506070.....	M 33
S84212005.....	M 132	SF3108300.....	M 136	T4506100.....	M 33
S84224005.....	M 132	SF3112100.....	M 136	T4506200.....	M 33
S84224010.....	M 132	SF3112150.....	M 136	T4512020.....	M 33
S84242005.....	M 132	SF3112151.....	M 136	T4512040.....	M 33
S84248005.....	M 132	SF3112251.....	M 136	T4512050.....	M 33
S84406003.....	M 133	SF3112300.....	M 136	T4512100.....	M 33

# INDEX REFERENCE BAILEY

Référence Bailey	Page	Référence Bailey	Page	Référence Bailey	Page
T4518025.....	M 33	T5530080.....	M 38	T6060040.....	M 44
T4524020.....	M 33	T5532033.....	M 38	T6060055.....	M 44
T4524030.....	M 33	T5536020.....	M 38	T6060060.....	M 44
T4524040.....	M 33	T5536030.....	M 38	T6506020.....	M 40
T4524050.....	M 33	T5536033.....	M 38	T6506040.....	M 40
T4530020.....	M 33	T5536035.....	M 38	T6506080.....	M 40
T4530040.....	M 33	T5536040.....	M 38	T6506100.....	M 40
T4532033.....	M 33	T5536050.....	M 38	T6506200.....	M 40
T4536020.....	M 33	T5540050.....	M 38	T6512020.....	M 40
T4536035.....	M 33	T5548020.....	M 38	T6512040.....	M 40
T4548020.....	M 33	T5548025.....	M 38	T6512050.....	M 40
T4548030.....	M 33	T5548030.....	M 38	T6512100.....	M 40
T4548040.....	M 33	T5548040.....	M 38	T6512120.....	M 40
T4560020.....	M 33	T5548050.....	M 38	T6518025.....	M 40
T4606020.....	M 34	T5552020.....	M 38	T6518055.....	M 40
T4606040.....	M 34	T5560020.....	M 38	T6524020.....	M 40
T4606050.....	M 34	T5560030.....	M 38	T6524025.....	M 40
T4606100.....	M 34	T5560040.....	M 38	T6524040.....	M 40
T4606200.....	M 34	T5560050.....	M 38	T6524050.....	M 40
T4612020.....	M 34	T5570020.....	M 38	T6524080.....	M 40
T4612040.....	M 34	T5570040.....	M 38	T6524100.....	M 40
T4612050.....	M 34	T5580020.....	M 38	T6526040.....	M 40
T4612100.....	M 34	T5606020.....	M 35	T6530020.....	M 40
T4616060.....	M 34	T5606040.....	M 35	T6530040.....	M 40
T4618025.....	M 34	T5606050.....	M 35	T6536020.....	M 40
T4624020.....	M 34	T5606100.....	M 35	T6536040.....	M 40
T4624030.....	M 34	T5606160.....	M 35	T6536050.....	M 40
T4624040.....	M 34	T5606200.....	M 35	T6536060.....	M 40
T4624050.....	M 34	T5612020.....	M 35	T6548020.....	M 40
T4628020.....	M 34	T5612040.....	M 35	T6548025.....	M 40
T4628040.....	M 34	T5612050.....	M 35	T6548030.....	M 40
T4630020.....	M 34	T5612100.....	M 35	T6548040.....	M 40
T4630030.....	M 34	T5616060.....	M 35	T6548050.....	M 40
T4630040.....	M 34	T5618025.....	M 35	T6548060.....	M 41
T4632033.....	M 34	T5624020.....	M 35	T6552020.....	M 41
T4636020.....	M 34	T5624030.....	M 35	T6560020.....	M 41
T4636035.....	M 34	T5624040.....	M 35	T6560040.....	M 41
T4648020.....	M 34	T5624050.....	M 35	T6560050.....	M 41
T4648030.....	M 34	T5624080.....	M 35	T6560060.....	M 41
T4660020.....	M 34	T5624100.....	M 35	T6570020.....	M 41
T4670020.....	M 34	T5626040.....	M 35	T6585024.....	M 41
T5506020.....	M 37	T5628040.....	M 35	T6806020.....	M 42
T5506040.....	M 37	T5628050.....	M 35	T6806040.....	M 42
T5506050.....	M 37	T5630020.....	M 35	T6806050.....	M 42
T5506080.....	M 37	T5630040.....	M 35	T6806080.....	M 42
T5506100.....	M 37	T5630050.....	M 35	T6806100.....	M 42
T5506200.....	M 37	T5632033.....	M 35	T6806200.....	M 42
T5512020.....	M 37	T5636020.....	M 35	T6812020.....	M 42
T5512040.....	M 37	T5636040.....	M 35	T6812030.....	M 42
T5512050.....	M 37	T5636050.....	M 35	T6812040.....	M 42
T5512080.....	M 37	T5648020.....	M 35	T6812050.....	M 42
T5512100.....	M 37	T5648025.....	M 35	T6812080.....	M 42
T5514020.....	M 37	T5648030.....	M 36	T6812100.....	M 42
T5516050.....	M 37	T5652020.....	M 36	T6812120.....	M 42
T5518025.....	M 37	T5660020.....	M 36	T6818025.....	M 42
T5518066.....	M 37	T5670020.....	M 36	T6818040.....	M 42
T5524020.....	M 37	T6006040.....	M 44	T6818100.....	M 42
T5524025.....	M 37	T6012020.....	M 44	T6824020.....	M 42
T5524030.....	M 37	T6012050.....	M 44	T6824025.....	M 42
T5524040.....	M 37	T6024020.....	M 44	T6824035.....	M 42
T5524050.....	M 37	T6024040.....	M 44	T6824040.....	M 42
T5524060.....	M 37	T6024050.....	M 44	T6824050.....	M 42
T5524080.....	M 37	T6024060.....	M 44	T6824060.....	M 42
T5526040.....	M 37	T6028045.....	M 44	T6824080.....	M 42
T5528020.....	M 37	T6028050.....	M 44	T6824100.....	M 42
T5528040.....	M 37	T6036020.....	M 44	T6828025.....	M 42
T5528050.....	M 37	T6036035.....	M 44	T6828040.....	M 42
T5530020.....	M 37	T6036050.....	M 44	T6828045.....	M 42
T5530030.....	M 37	T6048020.....	M 44	T6828050.....	M 42
T5530040.....	M 37	T6048030.....	M 44	T6830020.....	M 42
T5530050.....	M 37	T6060020.....	M 44	T6830025.....	M 42

# INDEX REFERENCE BAILEY

Référence Bailey	Page	Référence Bailey	Page	Référence Bailey	Page
T6830040.....	M 43	WB20061671.....	M 27	WE03050301.....	M 2
T6830050.....	M 43	WB20062001.....	M 27	WE03050601.....	M 2
T6830080.....	M 43	WB20063331.....	M 27	WE03050602.....	M 2
T6830100.....	M 43	WB20120171.....	M 27	WE0305060L.....	M 2
T6836020.....	M 43	WB20120301.....	M 27	WE03050751.....	M 2
T6836033.....	M 43	WB20120801.....	M 27	WE03051151.....	M 2
T6836040.....	M 43	WB20121001.....	M 27	WE03051251.....	M 2
T6836050.....	M 43	WB20121651.....	M 27	WE03060501.....	M 2
T6836100.....	M 43	WB20121921.....	M 27	WE03060601.....	M 2
T6848020.....	M 43	WB20140801.....	M 27	WE03060701.....	M 2
T6848025.....	M 43	WB20140802.....	M 27	WE03100271.....	M 2
T6848040.....	M 43	WB20141001.....	M 27	WE03120301.....	M 2
T6848050.....	M 43	WB20240301.....	M 27	WE03120401.....	M 2
T6850020.....	M 43	WB20240401.....	M 27	WE03120501.....	M 2
T6850050.....	M 43	WB20240501.....	M 27	WE03120601.....	M 2
T6860020.....	M 43	WB2024050R.....	M 27	WE03130251.....	M 2
T6860040.....	M 43	WB20240801.....	M 27	WE03140401.....	M 2
T6860050.....	M 43	WB20280401.....	M 27	WE03140651.....	M 2
T6860060.....	M 43	WB28061501.....	M 29	WE03140801.....	M 2
T6870020.....	M 43	WB28061671.....	M 29	WE03180261.....	M 2
T6870025.....	M 43	WB28062001.....	M 29	WE03240201.....	M 2
T6870030.....	M 43	WB28062501.....	M 29	WE03280241.....	M 2
T6870040.....	M 43	WB28063171.....	M 29	WE03280281.....	M 2
T6880020.....	M 43	WB28063331.....	M 29	WE03360201.....	M 2
T6880040.....	M 43	WB28065001.....	M 29	WE04010301.....	M 3
T6890020.....	M 43	WB28068301.....	M 29	WE04010701.....	M 3
T7006041.....	M 47	WB28071001.....	M 29	WE04011001.....	M 3
T7012020.....	M 47	WB28121001.....	M 29	WE04031901.....	M 3
T7017045.....	M 47	WB28121251.....	M 29	WE04050601.....	M 3
T7024055.....	M 47	WB28121651.....	M 29	WE04051151.....	M 3
T7024100.....	M 47	WB28121831.....	M 29	WE04060301.....	M 3
T7045037.....	M 47	WB28122501.....	M 29	WE04060401.....	M 3
T9024040.....	M 49	WB28124001.....	M 29	WE04060601.....	M 3
T9024080.....	M 49	WB28140801.....	M 29	WE04061001.....	M 3
T9024125.....	M 49	WB28141901.....	M 29	WE04062001.....	M 3
T9028105.....	M 49	WB28142401.....	M 29	WE04100151.....	M 3
T9040075.....	M 49	WB28142701.....	M 29	WE04120201.....	M 3
T9048045.....	M 49	WB28240801.....	M 29	WE04120351.....	M 3
T9048065.....	M 49	WB28241251.....	M 29	WE04120401.....	M 3
T9060035.....	M 49	WB28241651.....	M 29	WE04120601.....	M 3
T9060050.....	M 49	WB28242081.....	M 29	WE04120801.....	M 3
T9070050.....	M 49	WB28280601.....	M 29	WE04121001.....	M 3
TE038012005.....	M 82	WB28281001.....	M 29	WE04130301.....	M 3
TE038024005.....	M 82	WB28282001.....	M 29	WE04140801.....	M 3
TE038048005.....	M 82	WB2830002F.....	M 29	WE04160301.....	M 3
TE038160005.....	M 82	WB28320631.....	M 29	WE04240351.....	M 3
TE038255005.....	M 82	WB28600401.....	M 29	WE04240352.....	M 3
TE038260010.....	M 82	WB35060900.....	M 31	WE04240401.....	M 3
TE043024005.....	M 83	WB35061200.....	M 31	WE04280251.....	M 3
TE043027005.....	M 83	WB35120417.....	M 31	WE04280401.....	M 3
TE043130010.....	M 83	WB35120583.....	M 31	WE04480251.....	M 3
TE043250007.....	M 83	WB35120667.....	M 31	WE05010601.....	M 4
TE043260010.....	M 83	WB35120833.....	M 31	WE05040601.....	M 4
TERASAKI2824.....	M 14	WB35121000.....	M 31	WE05060401.....	M 4
TERASAKI2840.....	M 14	WB35121250.....	M 31	WE05060402.....	M 4
		WB35121500.....	M 31	WE05062001.....	M 4
		WB35121667.....	M 31	WE05062002.....	M 4
		WB35121750.....	M 31	WE05120301.....	M 4
		WB35130690.....	M 31	WE05120401.....	M 4
		WB35240208.....	M 31	WE05120402.....	M 4
		WB35240292.....	M 31	WE05120501.....	M 4
		WB35240417.....	M 31	WE05120801.....	M 4
		WB35240625.....	M 31	WE05121001.....	M 4
		WB35240875.....	M 31	WE05240351.....	M 4
		WE02050601.....	M 1	WE05280401.....	M 4
		WE02050801.....	M 1	WE05280402.....	M 4
		WE02051151.....	M 1	WE06023501.....	M 5
		WE02120501.....	M 1	WE06030151.....	M 5
		WE02240201.....	M 1	WE06050151.....	M 5
		WE03030151.....	M 2	WE06050601.....	M 5
		WE03050211.....	M 2	WE06060401.....	M 5

## V

VS10045008.....	M 85
VS10045008R.....	M 85
VS10070008.....	M 85
VS10070008R.....	M 85

## W

WA04030601.....	M 6
WA04060501.....	M 6
WA04090501.....	M 6
WA04120501.....	M 6
WB20060301.....	M 27
WB20060401.....	M 27
WB20060801.....	M 27
WB20061501.....	M 27

# INDEX REFERENCE BAILEY

Référence Bailey	Page	Référence Bailey	Page	Référence Bailey	Page
WE06060402.....	M 5	XWB28125831.....	M 30		
WE06060752.....	M 5	XWB28125831F.....	M 30		
WE06061001.....	M 5	XWB28242081.....	M 30		
WE06062001.....	M 5	XWB28242081F.....	M 30		
WE06062002.....	M 5	XWB28243131.....	M 30		
WE06062003.....	M 5	XWB28243131F.....	M 30		
WE06100151.....	M 5	XWB28244171.....	M 30		
WE06120401.....	M 5	XWB28244171F.....	M 30		
WE06120601.....	M 5	XWB28282001.....	M 30		
WE06140801.....	M 5	XWB28282001F.....	M 30		
WE06140802.....	M 5				
WE06141001.....	M 5	<b>Z</b>			
WE06180401.....	M 5	ZSILICT114A.....	M 149		
WE06240401.....	M 5	ZSILICT114B.....	M 149		
WE06240501.....	M 5	ZSILICT114G.....	M 149		
WE06240601.....	M 5	ZSILICT114R.....	M 149		
WE06280241.....	M 5	ZSILICT114Y.....	M 149		
WE06280401.....	M 5	ZSILICT134A.....	M 149		
WE06280402.....	M 5	ZSILICT134B.....	M 149		
WE06280403.....	M 5	ZSILICT134G.....	M 149		
WE06280601.....	M 5	ZSILICT134R.....	M 149		
WE06360201.....	M 5	ZSILICT134Y.....	M 149		
WE06480201.....	M 5	ZSILICT1A.....	M 149		
WE06600201.....	M 5	ZSILICT1B.....	M 149		
WN03120602.....	M 32	ZSILICT1G.....	M 149		
WN04120402.....	M 32	ZSILICT1R.....	M 149		
WN04121002.....	M 32	ZSILICT1Y.....	M 149		
WN04280402.....	M 32	ZSILICT314A.....	M 149		
WN05141004.....	M 32	ZSILICT314B.....	M 149		
WN05240402.....	M 32	ZSILICT314G.....	M 149		
WP04040601.....	M 7	ZSILICT314R.....	M 149		
WP04060251.....	M 7	ZSILICT314Y.....	M 149		
WP04060401.....	M 7				
WP04060402.....	M 7				
WP04060403.....	M 7				
WP04060601.....	M 7				
WP04060603.....	M 7				
WP04060801.....	M 7				
WP04080401.....	M 7				
WP04080402.....	M 7				
WP04080403.....	M 7				
WP04080601.....	M 7				
WP04080603.....	M 7				
WP04080801.....	M 7				
WP04080803.....	M 7				
WP04120401.....	M 7				
WP04120402.....	M 7				
WP04120403.....	M 7				
WP04120601.....	M 7				
WP04120603.....	M 7				
WP04140401.....	M 7				
WP04140402.....	M 7				
WP04140403.....	M 7				
WP04140803.....	M 7				
WP04240401.....	M 7				
WR20060301.....	M 28				
WR20120831.....	M 28				
WR20140301.....	M 28				
WR20280301.....	M 28				
WR20480251.....	M 28				
WR20600201.....	M 28				
<b>X</b>					
XWB28122501.....	M 30				
XWB28122501F.....	M 30				
XWB28124171.....	M 30				
XWB28124171F.....	M 30				
XWB28124172.....	M 30				
XWB28124172F.....	M 30				
XWB28125001.....	M 30				
XWB28125001F.....	M 30				

## INDEX NUMERO UNIQUE/REFERENCE BAILEY

Numéro unique	Référence Bailey	Page	Numéro unique	Référence Bailey	Page
1112	WB28121001	M 29	331	MF06010601	M 19
112	EL0120220	M 93	334	MG06280404	M 22
1177	E28036085	M 77	334LSV	MG06280601	M 22
1309	E28012183	M 76	335	MS06280402	M 25
1487	E28014200	M 76	336	MG06140803	M 21
158	WB28142401	M 29	337	MG06062001	M 21
159	WB28061501	M 29	338	MF06020601	M 19
1705	WE06140802	M 5	342	MS06060401	M 24
172	MF14050601	M 17	344	MF06100151	M 19
173	MF14051151	M 17	345	MF06060401	M 19
1730	WE06060401	M 5	349	MF06062003	M 19
1739	WE06060752	M 5	367	MF06100401	M 19
174	MF14060701	M 17	368	MF06022001	M 19
175	MF14062001	M 17	370	MF06180401	M 20
1764	WE06280403	M 5	373	MS06140802	M 25
1764LSV	WE06280601	M 5	375	MF06030151	M 19
1768	MS06062001	M 24	376	MF06280601	M 20
177	MF14120601	M 17	377	MF06060751	M 19
178	MF14121001	M 17	378	MS06062002	M 24
1784	WE06062001	M 5	379	MG06062002	M 21
179	MF14240201	M 17	380	MF06060402	M 19
180	MF14280241	M 17	381	MF06062002	M 19
181	MF14280401	M 17	382	MF06140801	M 20
1813	B28014100	M 62	385	MF06280402	M 20
1815	B28014200	M 62	386	MG06140802	M 21
1820	B28028100	M 62	387	MF06280403	M 20
1823	E28048100	M 78	388	MG06280403	M 22
1826	B28018170	M 62	394	MF06120401	M 19
1829	B28028070	M 62	397	MG06100401	M 21
1835	B28055050	M 64	398	MG06062003	M 21
1850	B28005090	M 60	399	MS06280401	M 25
1864	B28028170	M 62	40	E28006150	M 76
1869	WE06100151	M 5	400	WB28281001	M 29
1873	B28028200	M 63	4015	BP24060601	M 12
1891	B28014240	M 62	4032	BP24120401	M 12
192	WE05062001	M 4	4060	BP24240351	M 12
194	MF14120201	M 17	411	E28006060	M 75
194	WE05280402	M 4	43	B28002500	M 60
2041	WE06240601	M 5	44	B28006250	M 61
2102	WE06180401	M 5	457	MG06220401	M 22
2112	WE06062003	M 5	46	E28006250	M 76
2114	WE04060601	M 3	47	B28006150	M 61
2135	WE04010301	M 3	49	B28002060	M 60
2158	WE06030151	M 5	501	WB28124001	M 29
2162	WE06141001	M 5	504	WB28122501	M 29
2169	WE06023501	M 5	515	WE04051151	M 3
2174	WE06120401	M 5	516	WB28063331	M 29
2176	WE06240501	M 5	5682	MS06140501	M 25
2180	WE06060402	M 5	583	WE04050601	M 3
2181	WE06062002	M 5	6022	WE03050211	M 2
2182	WE06140801	M 5	6033	WE06280241	M 5
2185	WE06280401	M 5	619	BP24280251	M 12
2187	WE06280402	M 5	6201	MG06600201	M 22
2200	WE06050601	M 5	634	WE04062001	M 3
222	EL0220250	M 93	640	B24006300	M 68
222	EL0225250	M 93	641	B24006500	M 68
243	EL0233270	M 93	643	B24012185	M 68
253	MG0602350L	M 21	655	WB28282001	M 29
259	WB28062501	M 29	656	WB28280601	M 29
266	MG06023501	M 21	658	WB28140801	M 29
268	MF06023501	M 19	680	WE03050601	M 2
280	MS06121271	M 24	683	WE03050602	M 2
3024	MF03120301	M 16	6833	WE02050601	M 1
3092	MF03280201	M 16	6838	WE03280241	M 2
3094	MF03060401	M 16	6839	MF03280241	M 16
32	MF03120601	M 16	685	MF03050601	M 16
324	WE04031901	M 3	687	MS06240401	M 25
327	MF06280404	M 20	698	MG06010601	M 21
328	MF06062001	M 19	7051	WE03120401	M 2
329	MF06030301	M 19	709	MG06100151	M 21
330	MF06140803	M 20	713	WE03050751	M 2

## INDEX NUMERO UNIQUE/REFERENCE BAILEY

Numéro unique	Référence Bailey	Page
714.....	MF03050751 .....	M 16
715.....	WE03051151 .....	M 2
7153.....	WE02051151 .....	M 1
718.....	MF03051151 .....	M 16
7205.....	WE03030151 .....	M 2
7210.....	WE03050301 .....	M 2
7216.....	WE03051251 .....	M 2
7218.....	WE03100271 .....	M 2
7219.....	WE03120601 .....	M 2
7220.....	WE03180261 .....	M 2
7241.....	MF03180261 .....	M 16
73.....	WB20140801 .....	M 27
73.....	WB20140802 .....	M 27
7309.....	BP24060602 .....	M 12
7310.....	BP24062001 .....	M 12
7312.....	MS06023501 .....	M 24
7313.....	MS06030151 .....	M 24
7318.....	MS06050601 .....	M 24
7319.....	MS06051151 .....	M 24
7327.....	BP36280402 .....	M 13
7328.....	BP36062002 .....	M 13
7330.....	BP36140802 .....	M 13
7333.....	MF06050602 .....	M 19
7335.....	MF06051151 .....	M 19
7347.....	MG06050602 .....	M 21
7349.....	BP36062003 .....	M 13
7351.....	MG06060402 .....	M 21
7352.....	MG06061502 .....	M 21
7354.....	MG06120401 .....	M 21
7355.....	MG06280402 .....	M 22
7356.....	MG06280651 .....	M 22
7361.....	BP36050601 .....	M 13
7362.....	BP36051151 .....	M 13
7367.....	BP36100401 .....	M 13
7370.....	BP36180401 .....	M 13
7371.....	BP36120401 .....	M 13
7375.....	BP36030151 .....	M 13
7377.....	BP36060751 .....	M 13
7380.....	BP36060402 .....	M 13
7382.....	BP36140801 .....	M 13
7387.....	BP36280401 .....	M 13
749.....	WE04010701 .....	M 3
753.....	WE04120601 .....	M 3
754.....	WE04120801 .....	M 3
7583.....	BP24050601 .....	M 12
7590.....	BP24480251 .....	M 12
7632.....	BP24280401 .....	M 12
7646.....	BP24140801 .....	M 12
7683.....	BP13050601 .....	M 8
7683.....	BP23050601 .....	M 9
770.....	WE04240352 .....	M 3
7714 SPECIAL.....	BP137714.....	M 11
7714.....	BP13050751 .....	M 8
7715.....	BP13051151 .....	M 8
772.....	WE04120351 .....	M 3
7748.....	BP36480251 .....	M 13
7839 SPECIAL.....	BP137839.....	M 11
7839.....	BP13280241 .....	M 8
7839.....	BP23280241 .....	M 9
7868.....	BP36023501 .....	M 13
7876.....	BP36280601 .....	M 13
7945.....	BP36060401 .....	M 13
7968.....	BP36022001 .....	M 13
8022.....	MF03050211 .....	M 16
8097 SPECIAL.....	BP138097.....	M 11
8097.....	BP13120601 .....	M 8
8097.....	BP23120601 .....	M 9
8099.....	BP23180261 .....	M 9
8102.....	MF03010751 .....	M 16
8111.....	WE03140651 .....	M 2
8112.....	MF03140651 .....	M 16

Numéro unique	Référence Bailey	Page
8362.....	MS06140801 .....	M 25
84.....	WB20060401 .....	M 27
85.....	WB20280401 .....	M 27
8608.....	WE04100151 .....	M 3
8627.....	WE04280401 .....	M 3
8632.....	MF04280401 .....	M 18
8640.....	WE04140801 .....	M 3
8660.....	MF04060401 .....	M 18
8661.....	WE04060401 .....	M 3
8666.....	WE02050801 .....	M 1
8669.....	MS06010601 .....	M 24
8691.....	MS06100151 .....	M 24
8704.....	MG06020601 .....	M 21
8705.....	MG06060401 .....	M 21
8708.....	MG06060751 .....	M 21
871.....	WE03140401 .....	M 2
906.....	WB35130690 .....	M 31
912.....	WB35121000 .....	M 31
917.....	WB35121250 .....	M 31
923.....	WB35120833 .....	M 31
925.....	WB35121667 .....	M 31
927.....	WB35061200 .....	M 31
939.....	WB35060900 .....	M 31
987.....	E24012185 .....	M 87
KPR102.....	PK0240700 .....	M 97
KPR103.....	PK0360750 .....	M 97
KPR104.....	PK0220470 .....	M 97
KPR112.....	PK0600750 .....	M 97
KPR113.....	PK0480750 .....	M 97
KPR118.....	PK0720750 .....	M 97
KPR1941.....	PK0475500 .....	M 97
KPR5984.....	PK0401000 .....	M 97
KPRK1.....	PK0240500 .....	M 97
PR12.....	PR0595500 .....	M 95
PR13.....	PR0475500 .....	M 95
PR15.....	PR0480500 .....	M 95
PR16.....	PR1250250 .....	M 95
PR17.....	PR0490300 .....	M 95
PR18.....	PR0720500 .....	M 95
PR2.....	PR0238500 .....	M 95
PR20.....	PR0863500 .....	M 95
PR3.....	PR0360500 .....	M 95
PR30.....	PR0375860 .....	M 95
PR4.....	PR0233270 .....	M 95
PR5.....	PR0235350 .....	M 95
PR6.....	PR0247300 .....	M 95
PR7.....	PR0370300 .....	M 95
PR8.....	PR0190650 .....	M 95
PR9.....	PR0270150 .....	M 95

Ce catalogue a été réalisé avec beaucoup d'attention et de soin et nous sommes convaincus qu'au moment de l'impression, les informations y figurant seront correctes.

Néanmoins, Bailey Electric & Electronics bv ne pourra pas être tenue pour responsable concernant d'éventuelles erreurs dans les descriptions et dessins ou d'autres erreurs d'impression.

Bailey Electric & Electronics bv est libre de supprimer ou de modifier des descriptions et des types de lampes sans préavis.

Photographie par Claudia Aaldijk.

© Droit d'auteur 2011 Bailey Electric & Electronics bv  
Aucune reproduction du contenu du catalogue possible sans autorisation écrite préalable.

# Bailey

